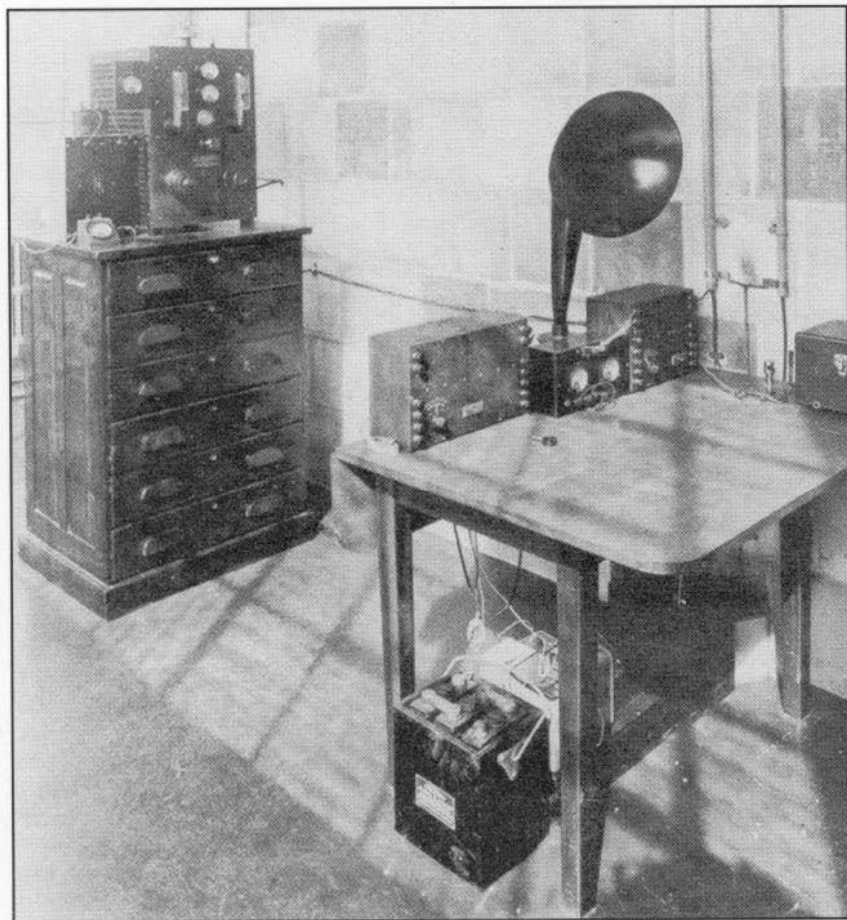




# THE AWA REVIEW



*1923: CKNC - North Bay, Ontario, Canada*

# THE A.W.A. REVIEW

Volume XIII  
2000



*Published By*  
**THE ANTIQUE WIRELESS ASSOCIATION, INC.**  
**Breesport, NY 14816**

*Devoted to research and documentation of the history of wireless communications.*

Member:  
American Association  
of Museums  
Regional Conference of  
Historical Agencies



ANTIQUE WIRELESS ASSOCIATION, INC.  
BREESSPORT, NEW YORK 11816

Founded 1952. Chartered  
as a non-profit corporation  
by the State of New York

---

## THE A.W.A. REVIEW

EDITOR

William B. Fizette, Ph.D.  
Henryville, PA

LAYOUT AND PRODUCTION:

William B. Fizette

### OFFICERS OF THE ANTIQUE WIRELESS ASSOCIATION

PRESIDENT: William B. Fizette, W2DGB  
VICE PRESIDENTS: Ronald E. Frisbie  
Geoffrey Bourne  
SECRETARY: Joyce Peckham  
TREASURER: Stanley J. Avery, WM3D  
CURATOR OF THE MUSEUM: Edward M. Gable, K2MP

### THE COVER

The photograph shows the entire studio facility of CKNC in North Bay, Ontario, Canada in the winter of 1923. On the file cabinet is a Northern Electric 3-A 50-watt broadcast transmitter. It used two Northern Electric R-211-D tubes and on R-205-D tube. On the table to the left of the R-518 horn speaker is a R-107 amplifier, and to the right a R-106 amplifier, all from Northern Electric. In 1931 the same equipment was outdated, and was sold surplus for \$500 to Roy Thompson who later claimed he had grossed \$80,000 from his broadcast station in North Bay. Lord Thompson of Fleet later owned one of the largest publishing and broadcasting empires in the world. His purchase of the *Times* of London and the *Sunday Times* was his entry to proper society in England.

Photo: Public Archives of Canada.

Reference: Warner Troyer, *The Sound and the Fury*.  
Toronto, Canada: John Wiley & Sons Canada Lt., 1980.

©2000 by the Antique Wireless Association, Inc.

ISBN 0-9704108-2-4

All rights reserved. No part of this publication may be reproduced, stored in a retrieval system, or transmitted, in any form or by any means, electronic, mechanical, photocopying, recording, or otherwise, without the prior written permission of the copyright owner.

Printed in the United States of America by  
Sun Litho-Print, Inc., East Stroudsburg, PA 18301.

☆ CONTENTS ☆

FOREWORD ..... 5

MANUFACTURE OF BROADCAST RECEIVERS BY THE  
NORTHERN ELECTRIC COMPANY IN THE 1920s  
Robert Murray ..... 7

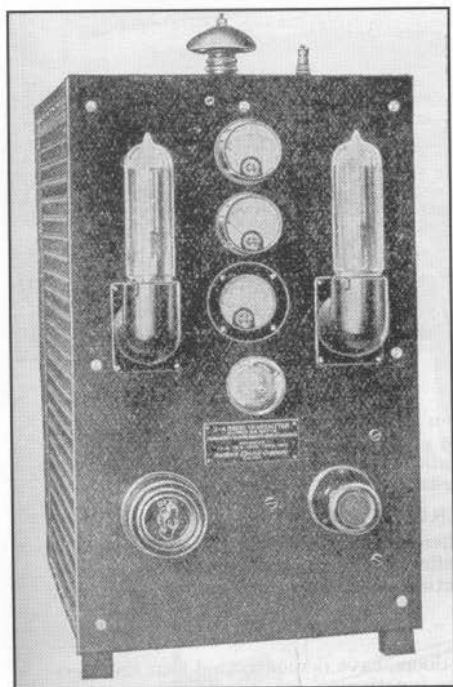
MARCONI v. BRITISH RADIO TELEGRAPH AND  
TELEPHONE COMPANY: THE PATENT CASE  
THAT CHANGED THE WORLD  
Graeme Bartram ..... 39

MARCONI'S TRANSATLANTIC TRIUMPH — a skip into history  
Bartholomew Lee ..... 81

RADIO DIRECTION FINDING AND "HUFF-DUFF"  
Richard C. Foster and Pierre Demerseman ..... 98

"ANYTHING YOU CAN THINK OF DOING, WE'D JUST DO IT"  
THE EARLY HISTORY OF CHARLOTTE'S RADIO  
STATION WBT  
Pamela Grundy ..... 115

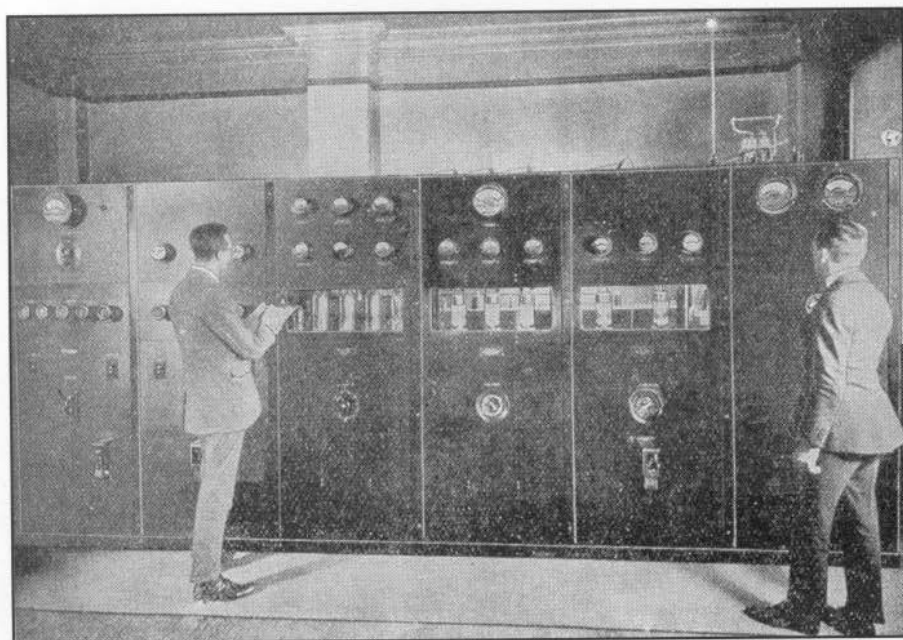
EARLY RADIO STATIONS: WEEDS AND TREES  
George A. Freeman ..... 124



*Northern Electric radio broadcast transmitting equipment. The No. 3-A is a 50-watt transmitter for use in point-to-point communications work for lumber camps, forestry preservation, police outposts, aircraft services, and emergency work.*

*The 5000-watt assembly was used in many of the up-to-date commercial broadcasting stations in Canada of the time. The bays are, from left to right, the AC current power control, the DC power control, the master oscillator and modulator, rectifier panel, the radio frequency amplifier, and the antenna control.*

*Source: The Northern Electric Company General Catalog, 1925*



## FOREWORD

The Antique Wireless Association presents for your reading interest Volume 13 of the *AWA Review*, with some unusual content.

The lead article is by well-known Canadian member Robert Murray, who explores in depth the Canadian Northern Electric manufacturing company and its radio products. The detailed listings and numerous photos should prove to be of considerable interest to the radio collectors and historians, especially to those who may not have known much about the products of this rarely mentioned company.

Graeme Bartram of Australia, a relative newcomer to our pages, recounts a little-known legal case that led to the commercial dominance of the Marconi Company in the field of wireless telegraphic communications for many years. He also introduces us to another radio pioneer, John Graeme Balsillie. A key element within the story is the famous Marconi 7777 patent.

Next, Bart Lee, a well-known historian and writer, continues with the Marconi theme by exploring in depth the controversial "three dots" first message from England to Newfoundland on December 12, 1901. While writers over the years have cast doubts on the veracity of the Marconi claim, this paper draws on some little known sources to place this historic event in better perspective, and in the process, provide us with some very interesting reading.

Richard Foster of Coquituate, Mass., and Pierre Demerseman of Paris, France, have joined forces to produce a discussion of radio direction finding, and "Huff-Duff." This World War I secret weapon played a vital role in the Battle of the Atlantic, and was instrumental in reversing the very serious situation in favor of the Allies. Coupled with a history of radio direction finding, the authors explore the significant work of French engineer Henri Busignies, including details of his related patents.

Writer Pamela Grundy, of Charlotte, NC, who is well known to the members of the AWA Carolinas Chapter for her interest in early radio, has offered for our reading pleasure the early history of Charlotte's radio station WBT. The challenges facing the early radio station pioneers as the industry developed are reflected in this lively tale.

Following through on early radio stations, George Freeman, well known within AWA circles, tries his hand at authorship by exploring the theme of just how these pioneer stations came into being in the fledgling industry, and how some survived while many did not. Appended is a comprehensive list of these early stations, which, the author assures us, is still developing.

The editor wishes to express his appreciation and thanks to all the authors for their attention to detail in their respective papers, and willing and timely cooperation in the editing process. If errors do appear, it is not for the want of trying to avoid such. Also, as with all these AWA publications, comments are most welcome.

The Editor



## MANUFACTURE OF BROADCAST RECEIVERS BY THE NORTHERN ELECTRIC COMPANY IN THE 1920s

**Robert P. Murray**  
Winnipeg, MB, Canada

The history of the telephone and of radio are connected in several ways. The Bell System fought off competition and emerged as the dominant holder of telephone patents in the latter 1800s. They had a serious interest in the technology of audio circuits, acquiring, for example, DeForest's audion patents. When broadcasting began in the early 1920s, the Bell System became a major player in the market for broadcast transmitters. Others were well positioned to produce broadcast receivers, most notably R.C.A., the result of a merger between the American Marconi Company and General Electric.<sup>1</sup> One result of the radio group patent negotiations in 1921 was that AT&T, or more specifically Western Electric, was to continue making broadcast transmitting equipment but was prevented from making domestic broadcast receivers.

In Canada there was a similar radio patent pool, although it came a couple of years later. Most of the players were subsidiaries of the U.S. companies in the business of making broadcast equipment, but events took a different turn. Specifically with respect to the telephone industry, the Bell Telephone Company of Canada, Ltd., through their subsidiary Northern Electric would continue to provide broadcast transmitters, *and* they were able to manufacture home broadcast receivers.

Why was there this difference between Canada and the U.S. in the manufacturing environment? One possibility, although I have never seen it documented, is that the U.S. radio group was created close to the beginning of broadcasting in both countries, in 1921. Despite accounts of the forward thinking of David Sarnoff at R.C.A., and his prediction of the Radio Music Box,<sup>1</sup> no one had yet demonstrated the future potential of broadcasting in 1921. On the other hand, the Canadian patent pool dates from 1923, a year or more after broadcasting had begun. It is more likely that, by then, AT&T would have seen a glimmer of the vast enterprise that broadcasting would become, and chose to negotiate more firmly for an unfettered position in it for its subsidiary Northern Electric.



But I am getting ahead of myself. Several details in the history of the telephone companies are where this story begins.

### Background

Looking back, Melville Bell, Alexander Graham Bell's father in Brantford, Ontario, was assigned the patent rights to the telephone in Canada, but he had neither the knowledge nor the interest to manage a telephone company.<sup>2</sup> It might even be fair to say he didn't want a telephone company. Alexander Graham Bell had first demonstrated the electrical transmission of intelligible speech in 1876. Already at that time, he was using the production capability and shop space of Charles Williams Jr. in Boston to manufacture his inventions (not to mention the help of Williams' employee Charles Watson, who had become Bell's assistant in 1875).<sup>3</sup>

The telephone as a business had its beginnings in 1877, and that same year Melville Bell advertised telephone service in Brantford. In order to do this, he signed an agreement with Charles Williams Jr. of Boston to deliver 1,000 hand telephones in exchange for the assignment of one-quarter of the patent in Canada. Melville Bell then appointed agents across Canada and launched the business of renting telephones. His efforts were not noticeably successful mainly because rights of way along highways could seldom be secured.<sup>4</sup> In 1879 Melville Bell sold his interests in the Canadian Bell patents to W.H. Forbes of Boston, who was the president of the National Bell Company, the result of a merger of New England Telephone and Bell Telephone in the United States.<sup>4</sup>

Charles Williams Jr. was unable to supply the 1,000 telephones to Melville Bell in Canada because of the huge demand in the United States. He therefore hired James Cowherd, a tinsmith in Brantford, who had helped Alexander Graham Bell make the original prototype of his invention, to be his Canadian agent. Cowherd successfully operated a factory at Brantford, and by October 1880 he had supplied 2,398 telephones to the Canadian company. Unfortunately, he died from tuberculosis on February 22, 1881.

The Western Electric Company was a subsidiary of Western Union, and quickly outclassed the small Bell and Williams manufacturing companies, turning out superior equipment. When Alec Bell agreed to an out of court settlement with Western Union in November of 1879 to the effect that Western Union would transfer its telephony business to Bell, and Bell would stay out of the telegraphy business, Western Electric became a subsidiary of Bell.<sup>3</sup> (Chap. 4)

In 1880 Charles F. Sise was sent by National Bell to bring some order to the telephone industry in Canada. He obtained a charter and organized the Bell Telephone Company of Canada in May of that year. The factory at

Brantford, initiated when Melville Bell owned the Canadian Telephone patent, was closed. From 1880 to 1882 repair shops at Montreal and Hamilton also did small manufacturing for the Company. During this period, the larger items of machinery were purchased from independent manufacturers in Canada or the U.S.A.<sup>4</sup>

The first Bell Telephone factory and repair shop was opened as the Mechanical Department in Montreal in 1882. As the Company was determined to manufacture in Canada, a new company was incorporated for the purpose in 1895, under the name of the Northern Electric and Manufacturing Company, Limited. The new company was granted broad powers, which would come to have significance at a later time. An excerpt from the letters patent incorporating the company reads:

(a) To manufacture and deal in brass, copper, and other metals and wires, rods, cables, lamps, castings and wrought metal articles, and their accessories; (b) To construct or contract for the construction for others of electric light, power, telegraph, telephone or street railway cable lines or plant and appliances or articles used in connection therewith; (c) To own, use and operate one or more line or lines of telegraphic or telephonic communication, and to purchase or lease electric light, telegraph or telephone plant, works or apparatus; (d) To acquire stock or shares in any electric light, telegraph, or metal wire, brass or street railway cable company as the consideration for goods, wares, or merchandise sold by the company to such other company in the ordinary course of business; (e) To acquire such licenses, patents or industrial designs as may be deemed necessary or expedient for the purposes of the said business and to alienate the same at pleasure.<sup>5</sup>

A larger factory was built equipped with more machinery to meet the growing demands of the Telephone Company. While machinery was installed in order that the equipment might be economically produced, the demand was not sufficient to keep the new machines fully utilized. Therefore it was decided to take profitable contracts for other than electrical apparatus, and in 1914 this company was merged with a wire and cable company, also owned by Bell Telephone of Canada, and renamed Northern Electric Company, Limited (NE).<sup>6</sup>

The history of stock ownership of the Northern Electric and Manufacturing Company, followed by Northern Electric Company, Limited, is shown in Table 1. For most of its history, the Bell Telephone Company of Canada owned the majority of NE stock, and Western Electric Company held a minority position. This relationship held until 1957, when a court decision required AT&T, and hence Western Electric, to divest its Canadian holdings.

**Table 1. Northern Electric Company Limited,  
History of Stock Ownership**

1. The Northern Electric and Manufacturing Company Limited (Incorporated 1895)			
Year	Bell Telephone Co.	Western Electric Co.	Others
1895			100%
1896	93%		7%
1906	55.80%	40.00%	4.20%
1910	55.20%	40.00%	4.80%
1911	50.00%	45.20%	4.80%
2. Northern Electric Company Limited (Incorporated 1914)			
1914	50.00%	43.60%	6.40%
1929	56.31%	43.57%	0.12%
1957	89.97%	10.52%	0.01%
1962	99.99%		0.01%
1964	100.00%		
Northern Electric Company, Ltd. Secretary's Department, August 17, 1967.			

Patents were suspended in Canada for the duration of the First World War, 1914-18. Having contracts for war production, the electric companies were accustomed for a time to manufacture equipment using all known patents, as needed.

On August 14, 1923, the Toronto Star announced that six electric companies had agreed to pool all their patents in order to avoid litigation and improve radio. This step was taken following the example of a number of companies in the United States in 1921, which had merged their radio-related patents with those of RCA. The companies involved in Canada were the Canadian General Electric Co., the Marconi Wireless Telegraph Co. of Canada, the Canadian Westinghouse Co., the Bell Telephone Co., the Northern Electric Co., and the International Western Electric Co.<sup>7</sup> Under the terms of the agreement, each company agreed to license the other parties within their natural fields.

In a 1924 newspaper article, the relationship between the telephone company and the manufacturer was explained as follows.<sup>8</sup> The Bell Telephone Co. in Canada began to appreciate early on that it required sophisticated and well-machined apparatus that would be reliable in service. They further realized that no such manufacturing business, familiar with telephone apparatus, existed in Canada. Catering to the needs of almost all of the telephone companies in Canada, it became apparent that economies of scale could be achieved if NE supplied all of the needs of Bell Telephone, and

be achieved if NE supplied all of the needs of Bell Telephone, and manufactured and stored all such equipment centrally. The manufacturing company also agreed to purchase and store goods not of its own manufacture, and to sell these goods on the open market where opportunities existed. In their 1925 general catalogue, NE lists for sale telephone equipment, signal and message systems, wires and cables, household appliances, illuminating equipment, wiring devices and electrical supplies (the largest section, and includes fire extinguishers), line construction material and tools, and power apparatus (anyone need a 200-hp electric motor?).<sup>9</sup>

Of course they also supplied radio broadcasting equipment. In reference to a 50-watt transmitter, they say, "In order to meet the ever-increasing demand for a small power radio transmitting equipment for use in the woods, the Northern Electric Company is offering ..." <sup>9</sup>(p. 39). (While sitting in the woods writing this article, it occurred to me that just maybe the advertiser had creative assistance from someone who lived in a more populated country.)

Radio was not the core business at NE, but a look at the financial information in Table 2 indicates that it was a substantial business. By 1924, it had grown to represent more than 9% of sales. (The years in Table 2 are not, strictly speaking, comparable, but after 75 years it is not possible to call the Finance Department and ask for the missing pages.)

It should also be recognized that the NE radio business included the manufacture of broadcast transmitters and the sale of transmitters made by the Western Electric Company. No information remains that treats the transmitter and receiver businesses separately, but evidently NE held a strong position in the broadcast transmitter market.

What can we infer from this table of financial information? Although gross profits for 1921 to 1923 are apparently calculated differently from those of 1924, and although net profits in 1924 appear to apply only to regional sales, we can still draw an overall generalization. Looking horizontally across the page at each definition of profit separately, it appears that radio was NE's most profitable area of business in each instance.

It is curious, then, that they abandoned the domestic receiver business altogether in 1926, as we shall later see. It is a year for which we have no corresponding financial data.

**Table 2. Northern Electric Company, Limited**  
**Sales and Gross Profits by Year by Class of Merchandise (a)**

Year	Telephone Apparatus	%	Wire and Cable	%	Radio	%	Merchandise Not N.E.	%	Total	Radio % of Total
<b>1921</b>										
Sales	4,721,017		2,752,996				4,263,373		11,737,386	
Gross Profits	1,143,000	24.2	228,000	8.3			394,898	9.3	1,765,898	
<b>1922</b>										
Sales	4,169,181		3,478,451		228,194		3,771,342		11,647,168	1.96%
Gross Profits	914,590	21.9	522,193	15.0	(b)		454,766	12.1	1,891,549	
<b>1923</b>										
Sales	5,600,290		5,279,738		719,048		4,585,016		16,184,092	4.44%
Gross Profits	1,369,465	24.5	846,514	16.0	245,378	34.1	569,053	12.4	3,030,410	8.10%
<b>1924 (c)</b>										
Sales	939,778		1,826,506		530,412		2,327,894		5,624,590	9.43%
Gross Profits	152,080	16.2	185,629	10.2	131,404	24.8	371,440	16.0	840,553	15.63%
Expenses	115,388		143,203		70,455		238,453		567,499	12.41%
Net Profits	36,692	3.9	42,426	2.3	60,949	11.5	132,987	5.7	273,054	22.32%

(a) For the years 1921 to 1923, this information appears to apply to the whole company.

(b) Gross profits included with telephone apparatus.

(c) For the year 1924, the available information applies only to the sales regions. Expenses in the sales regions include the categories Administration & Rent, Stores Expense, Sales Expense, and Financial Expense, so they are unrelated to the costs of production. Therefore net profits are not available for the whole company, and indeed may not have been available at the time.

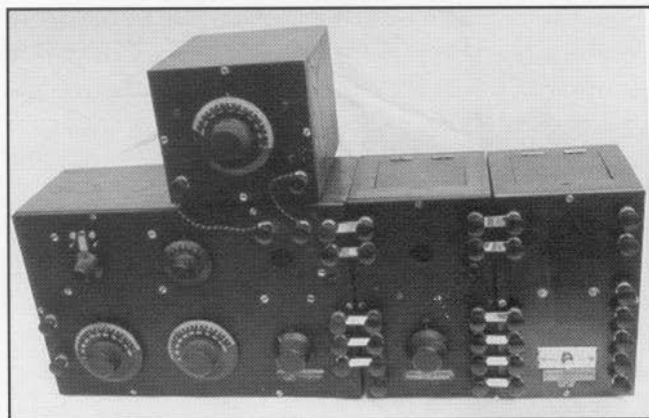
Being as diverse a manufacturer as it was, the initial move by Northern Electric into broadcast receivers must have seemed normal. In the Company's words, "With the advent of radio it was but natural that the Northern Electric, who have specialized in the reproduction of the human voice for over a quarter of a century, should be prepared to develop and perfect radio apparatus" (NE sales brochure, 1924).

So, what did they develop? A list of the early models, produced with the obvious help of the Western Electric Company, is shown in Table 3. All of these are battery sets.

**Table 3. The broadcast receiver models of the Northern Electric Company Ltd. in the 1920's.**

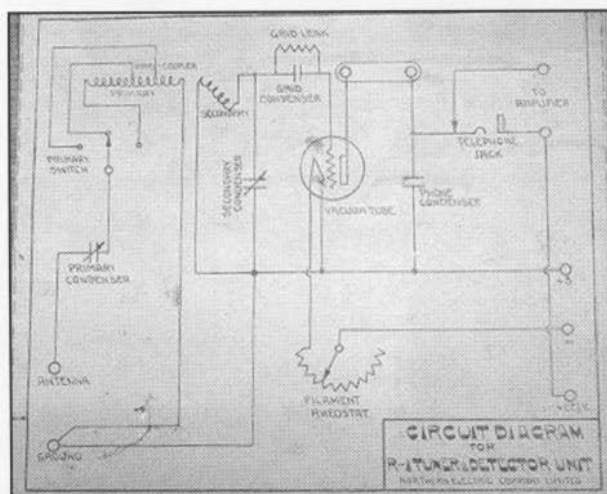
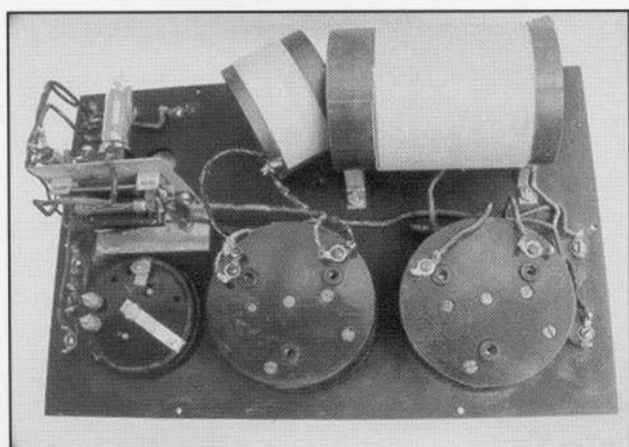
MODEL	YEAR	CIRCUIT	TUBES	STAGES	CABINET	PRICE
R-1	1922	Det.	1 (R215-A)	Det.	Box	30.00
R-2	1922	TRF	3 (R215-A)	2RF-Det.	Box	85.00
R-3	1923	TRF	4 (R215-A)	2RF-Det.-A	Table	100.00
R-4	1924	SH	6 (R215-A)	SH	Table	205.00
R-4-L	1926	SH	6 (R215-A) & 1 (R-221-DX)	SH	Table	
R-5/R-5A	1922	Amp.	1 (R215-A)	A.	Box	22.50
R-11	1923	Reg. Det.	1 (R215-A)	Det.	Box	40.00
R-12	1923	Reg. Det.	2 (R215-A)	Det.-A	Box	
R-15	1923	Amp.	1 (R215-A)	A.	Box	22.50
R-20	1923	Variometer	-		Box	10.00
Victor/Northern Electric Models						
R-20	1925	Reg. Det.	2 (R215-A)	Det.-A.	Table	42.00
R-21	1925	Reg. Det.	3 (R215-A)	Det.-AA	Table	68.00
R-22	1925	Reg. Det.	3 (R215-A)	Det.-AA	Victrola	54.00
R-23	1925	Reg. Det.	3 (R215-A)	Det.-AA	Victrola	64.00
R-24	1925	Reg. Det.	3 (R215-A)	Det.-AA	Table	
R-30	1925	TRF	5 (R221-DX)	TRF	Table	175.00
R-31	1925	TRF	5 (R221-DX)	TRF	Victrola	135.00
R-40	1926	SH	7	SH	Table	225.00
R-41	1926	SH	8	SH	Table	260.00
R-50	1925	TRF	5 (3-R215-A & 2-R221-DX)	TRF	Table	125.00
Northern Electric Power Amplifiers						
R-105	1923	Amp.	1 (R208-A)	Amp.	Box	30.00
R-106	1923	Amp.	2 (R208-A)	AA	Box	50.00
R-107	1923	Amp.	3 (R208-A)	AA	Box	70.00

Note: NE models are priced without tubes. Models offered jointly with the Victor Talking Machine Co. are priced with the tubes included.



**Figure 1.** Northern Electric R-1 receiver, R-5 and R-105 amplifiers, and R-20 variometer.

**Figure 2.** Northern Electric R-1 components side of front panel.



**Figure 3.** Circuit diagram for the R-1

## Domestic Receivers

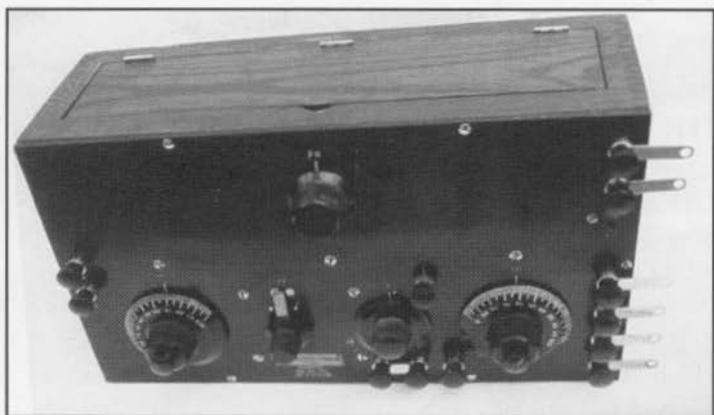
The Model R-1 appears to have been the first broadcast receiver produced by NE. That is to say, its model number and the fact that it was introduced in the first of a series of Northern Electric Radio Bulletins (No. 1000, Nov. 1, 1922) suggest that the R-1 was the earliest. (While NE did not first produce crystal receivers in Canada, the Canadian Marconi Company and the Canadian General Electric Company did.)

The Model R-1 is shown in Fig. 1, along with the R-5 and R-105 amplifiers, and the R-20 variometer sitting on top of the receiver. The R-1, as advertised in Radio Bulletin No. 1000, was not equipped to accommodate a variometer. Later models of R-1, including the one pictured here, came with two terminals on the front panel which allowed the user to interrupt the plate circuit of the single tube with the variometer. Sitting above the antenna transformer, the variometer provided enough adjustable feedback to convert the R-1 to a regenerative set. Without the variometer, (and with a nickel-plated jumper to replace it), the R-1 would have been a feeble performer. More will be said about the amplifiers later. The Model R-1, in combination with two R-5 amplifiers, tubes, batteries, phones and antenna equipment, was advertised as the R-1000 Radio Receiving Set for the price of \$105.00.

I found it curious that a manufacturer that had access to the Armstrong regeneration patent, from 1923 at least, would choose to offer a variometer for sale that would make their set regenerate but would not provide a complete regenerative set. Ralph Williams, in describing the Atwater Kent company, offers some suggestions on this topic.<sup>10</sup> He points out that regenerative sets were not easy to tune, and required some working knowledge of the adjustment procedure. Secondly, regenerative sets tended to go into oscillation, which became a major disadvantage as receivers became popular, in that the receiver transmitted an annoying signal close in frequency to the desired station. Finally, he observes that a regenerative set was not effective enough to survive as a family radio, although a patient radio enthusiast might make one behave well. For these reasons it was not in the interest of a manufacturer who sought to promote high quality radio receivers to include a regenerative model as a complete set.

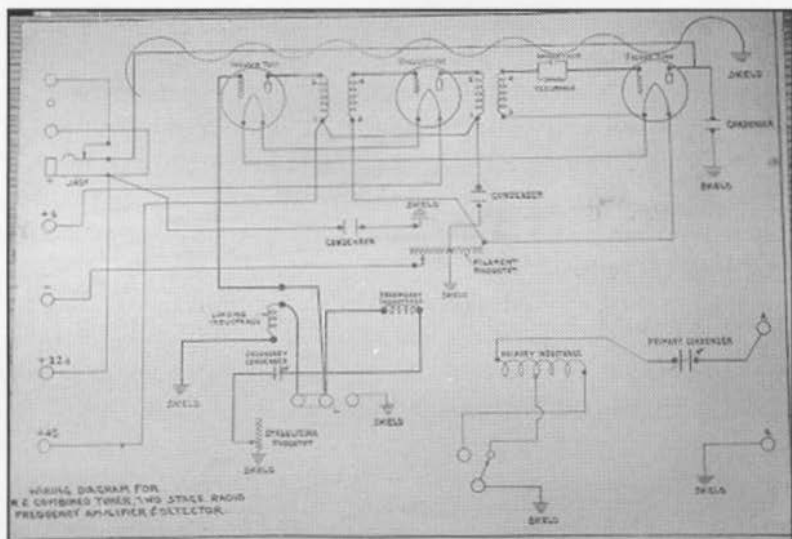
The business side of the receiver panel is shown in Fig. 2. The coils of the antenna transformer are along the top. The R-215A tube and the grid leak are fastened to what appears to be a zinc-plated steel shelf. The wiring is done with rubber-covered tinned 20-gauge solid wire, routed at least part of the time at right angles like buss wiring. The wiring of this set appears to be original, except for some "mouse-made" amendments to the insulation. At the time, NE acted as though it were manufacturing equipment for rent rather than sale, and they conveniently pasted schematics inside their cabinets, just as they did with early telephones (Fig. 3).



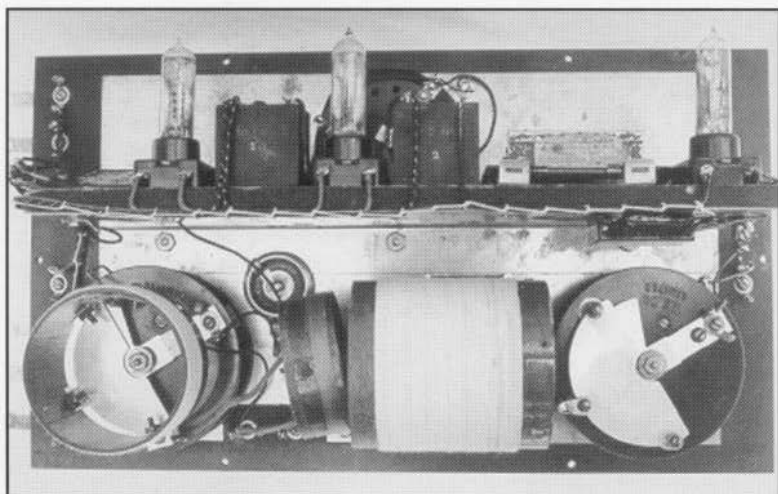


**Figure 4.** R-2 Short Wave Tuner and 2 Stage Radio Frequency Amplifier.

A month later, in December 1922, the R-2 receiver was launched. Its period of development probably overlapped considerably with that of the R1. It consists of a tuning circuit followed by two stages of rf amplification and a detector/audio amplifier. The controls (Fig. 4), in addition to the filament rheostat in the upper center of the panel, are (left to right) the primary condenser (PC), the primary inductance switch (PI), the coupler (C), the stabilizing rheostat (S), and the secondary condenser (SC). The circuit is designed much like those of crystal sets of the time, with the primary condenser and primary inductance connected in series and serving to tune the set. The loading inductance adjusts the coupling of the antenna circuit to the receiver (Fig. 5). There is no mention of feedback in the



**Figure 5.** Circuit diagram for the R-2.

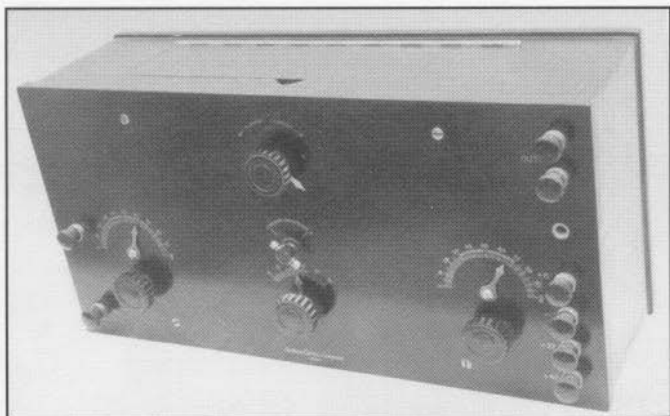


**Figure 6.** *R-2 components side of panel. The coils and the stabilizing rheostat marked "S" are not original.*

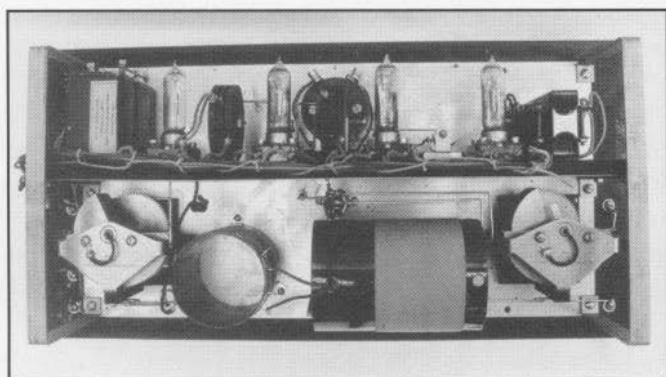
operating instructions, and I have not attempted to operate one myself. The stabilizing rheostat and the coils are not original in the set in Fig. 6. (Why is it that when a young family member takes an interest in an obsolete set, the coils are often the first component to go? The youthful interest may save the set, mind you, from the town dump. The coils in this set were restored with information obtained at the Hammond Museum, Guelph, Ontario, Canada.)

Western Electric obviously had a hand in designing this receiver, although at the time they were not producing any domestic broadcast receivers of their own. The NE description says, "The two stages of radio-frequency amplification embodied in this unit employ radio-frequency transformers specially designed by the engineers of the Western Electric Company, New York, for this purpose." These are labeled "1" and "2" on the tube shelf in Fig. 6. The wiring in this receiver has progressed from the rubber-covered solid wire to stranded, fabric-covered hook-up wire. The Model R-2, along with a R5-A amplifier, phones, tubes, batteries and antenna equipment was also marketed as the R2001 Radio-Frequency Receiving Set, price \$150.00.

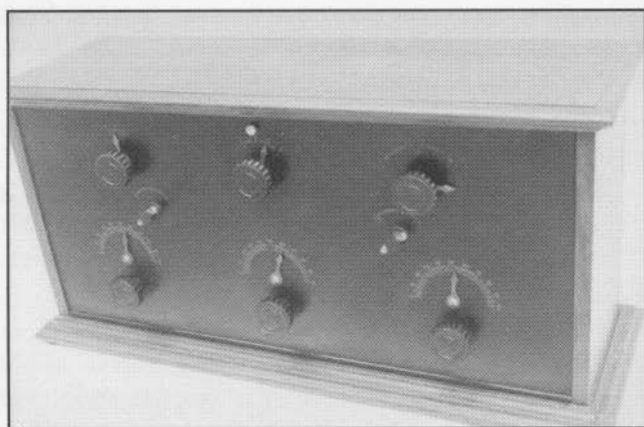
The July 1923 Radio Parts Catalogue makes reference to the R-3 receiver (Fig. 7), and the August 1, 1924 Radio Bulletin describes it in more detail. At this stage in development, they have managed to omit some of the controls from the panel. NE has also ceased the practice of pasting a schematic diagram of the circuit into the back of the cabinet. The set appears to be an improved model R-2. It has two stages of rf amplification, followed by a detector and an additional stage of audio amplification. It has fewer controls than the R-2. Neither model R-2 or R-3 had adopted the TRF design with three tuned stages cascaded after one another. The R-3 shares some similarities



**Figure 7.** *R-3 Four-tube Radio-frequency Set.*



**Figure 8.** *R3 components side of panel.*



**Figure 9.** *R-4 Superheterodyne Radio Receiving Set.*

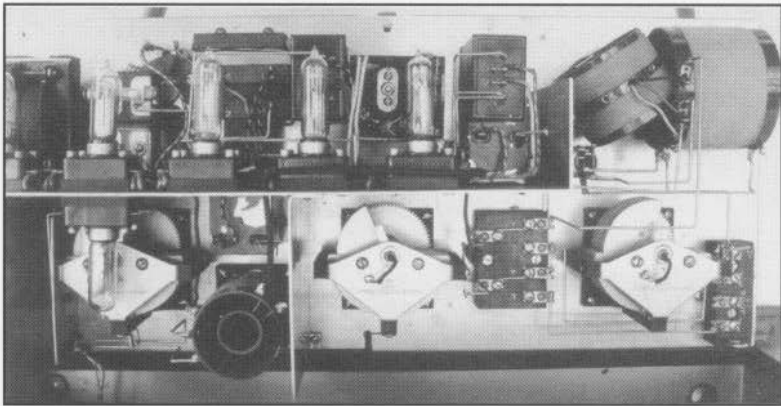


Figure 10. Inside the R-4 receiver.

with the Western Electric 3B.<sup>11</sup> Its internal parts are shown in Fig. 8. Compared to the R-2, the R-3 has adopted tuning condensers with gear-driven vernier controls, but the coil arrangement is much the same. The rf transformers have been re-designed, and an audio transformer has been added to couple the extra stage. The front panel markings are all done with transfer decals applied to the painted wood panel.

The R-4 superheterodyne was introduced in August of 1924. By this time NE had shared the benefit of the Canadian patent pool for about a year. Because of the increasing number of broadcast stations and their locations closer to each other on the broadcast band, radio designs with increased selectivity were required. The superheterodyne design was a logical answer. The R-4 in Fig. 9 has a somewhat fancier cabinet than its predecessors, but the similarities are also recognizable. Although previous sets have been equipped to operate with a loop antenna, a loop was not recommended. The R-4 is the first in the series for which NE feels sufficiently confident to recommend a loop, and offer one for sale. The inside of the receiver is

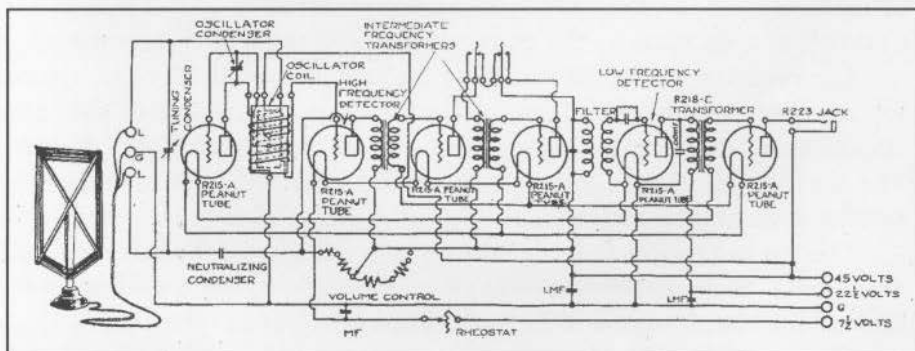


Figure 11. Circuit diagram of the R-4 receiver.



**Figure 12.** R-11 Radio Receiving Set and R-15 Amplifier.

shown in Fig. 10. In this set, heavy nickel-plated brass shielding separates the oscillator from the tuning section, and both from the rest of the set. The wooden box is shielded as well. The NE R-4 is quite similar to the Western Electric 4D.<sup>11</sup>

Although NE had discontinued the supply of receiver schematics with its sets in 1922, there is an exception for the R-4. One of their engineers, W.B. Cartmel, published an in-depth description of the set, including both a sketch of the receiver and a schematic diagram (Fig. 11) in the January 1925, issue of *Radio News of Canada*, a prominent radio magazine of the time.<sup>12</sup> The article runs to five full pages, only it doesn't mention the Northern Electric Company in relation to the receiver or Mr. Cartmel. He attributes the superheterodyne invention to Lucien Levy, without ever mentioning Howard Armstrong. It is difficult to assess now in retrospect whether publication of the details of the R-4 represents an act of defiance on the part of Mr. Cartmel, or a decision by the company to disseminate this information.

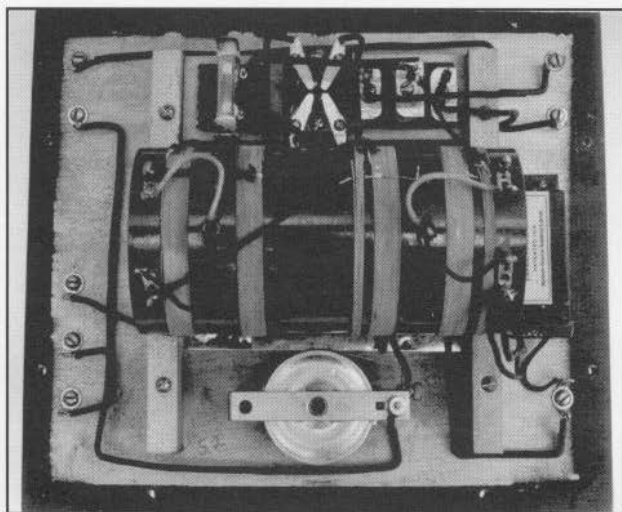
The receiver has an intermediate frequency around 50 KHZ, typical for the time, and this specimen at least has several images of the same station along the dial. NE advertising asserts that this does not happen. The set uses metal-core transformers at the intermediate frequency. The oscillator was tuned manually.

There was a model R-4-L produced later, which had the same external appearance, but with another stage of audio amplification contained in the back of the box. It used a R-221-DX tube as the power tube.

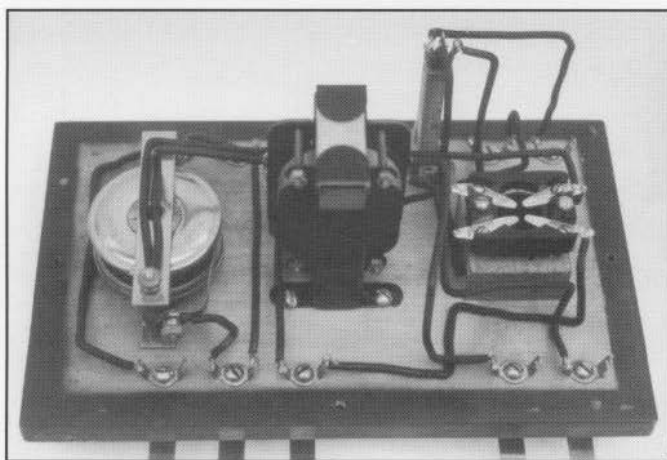
The model R-11/R-15 combination was offered in 1923 (Fig. 12). It was a simplified equivalent to the R-1 but somewhat less expensively made.

It had only three controls, tuning, feedback, and rheostat. Mind you, in August, 1924, the R-1 listed for \$30.00 and the R-11 listed for \$40.00. It was the first NE receiver described as “regenerative” in its original advertising, presumably because it was designed late in 1923, after the appearance of the Canadian patent pool. Its construction was not confined to NE parts. Some of these can be seen in the inside views of the receiver and amplifier (Fig. 13 and 14). There was no schematic diagram provided in the back of the case.

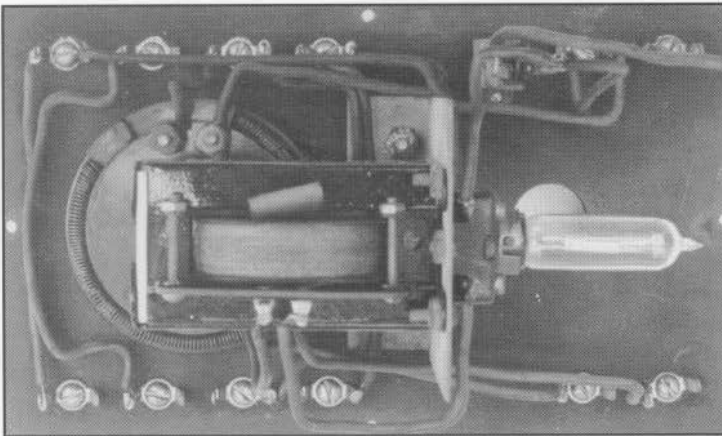
Model R-12 was another in the same series. It consisted of a one-tube regenerative detector with one stage of audio amplification included on the same chassis.



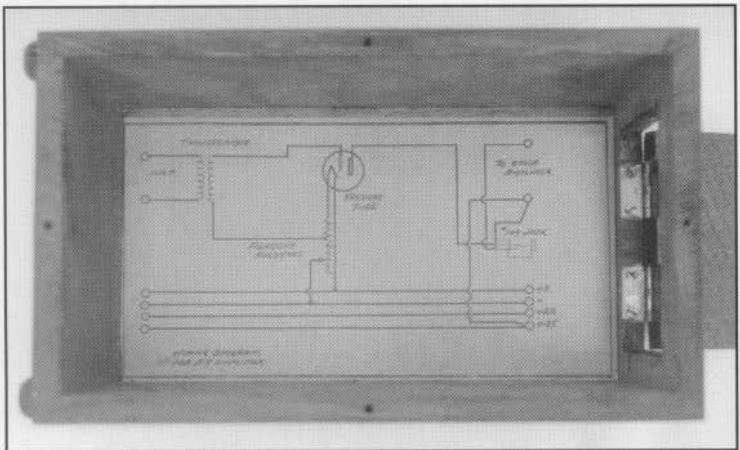
**Figure 13.** *R-11 components side of panel.*



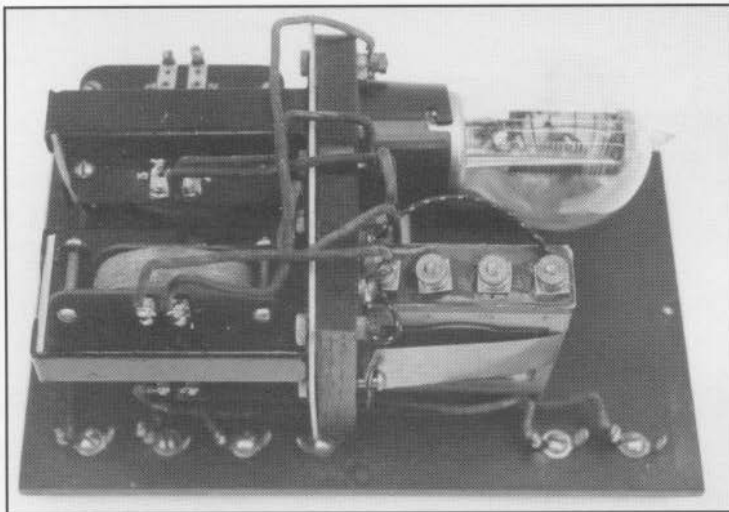
**Figure 14.** *R-15 components side of panel.*



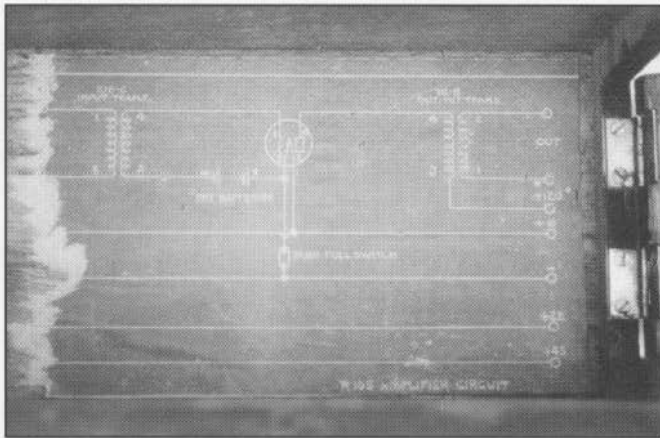
**Figure 15.** *Components side of the R-5 amplifier.*



**Figure 16.** *Schematic diagram of the R-5 amplifier.*



**Figure 17.** *Components side of the R-105 amplifier.*

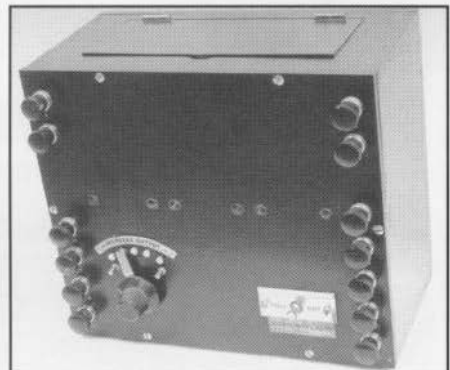


**Figure 18.** Schematic diagram of the R-105 amplifier.

### Northern Electric Power Amplifiers

At the time it produced its first broadcast receiver the R-1, NE also offered the R-5 amplifier to those customers who wanted a somewhat stronger signal in their headphones. These audio amplifiers used the R-215-A tube (Fig. 1 and 15), and could be added singly or in pairs to the output of a NE R-1 or R-2 set. The schematic diagram from the back of the case is shown in Fig.16. The rheostat in the R-5 amplifier was of a suitable value such that approximately 1.1 volts could be supplied to the filament when the A battery provided 3 volts. Later receivers (R-2 and upwards) used a 6 volt filament battery, and the R-5-A amplifier was fitted with a rheostat suitable for dropping this voltage to approximately 1.1 volts.

In 1923, still early in the sequence of NE receivers, a range of power amplifiers was offered to customers wanting loudspeaker performance from their receiver. The R-105 amplifier came in the same size box as the R-5, but contained a higher powered tube, initially the R-208-A and soon afterward the R-216-A. The R-105 is shown as the final amplifier in Fig. 1. The component side of the R-105 is shown in Fig. 17. The schematic diagram is in Fig. 18.



**Figure 19.** The R-106 Loud Speaker Amplifier. Dial plates on this amplifier are reproductions.

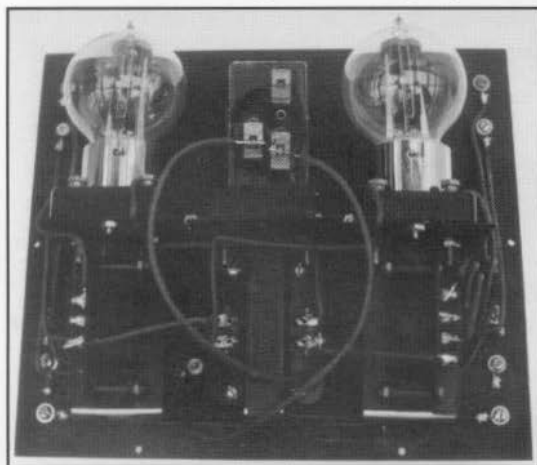


At the same time the Model R-106 was introduced (Fig. 19). Again this was first offered with two R-208-A tubes, but was soon changed to R-216-A tubes, one tube acting as driver and the other as final amplifier. There was a shelf on which a 9-volt C battery could be fastened (Fig. 20). Volume control was achieved by a tap switch selecting from five points on the input transformer (Fig. 21).

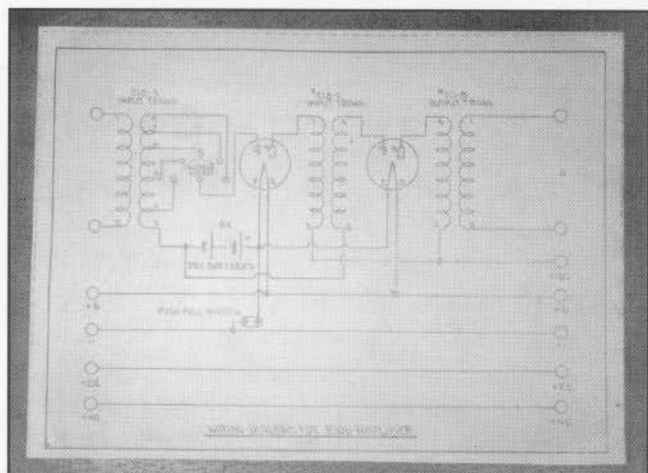
The Model R-107 amplifier is a two-stage audio amplifier with three R-216-A tubes, (originally R-208-As), acting as driver and push-pull stages (Fig. 22). This is the NE version of the Western Electric 7A amplifier. There are differences in both layout and cabinet design, but the circuit appears to be identical between the two.<sup>11</sup> There was no filament control in these amplifiers, as the tubes they were using worked well at a full 6 volts and the manufacturer saw no need for one. End users, however, often added one as an "owner improvement." The R-107, like the R-106, also controls volume by selecting taps on the input transformer (Fig. 23).

### Victor/Northern Electric Receivers

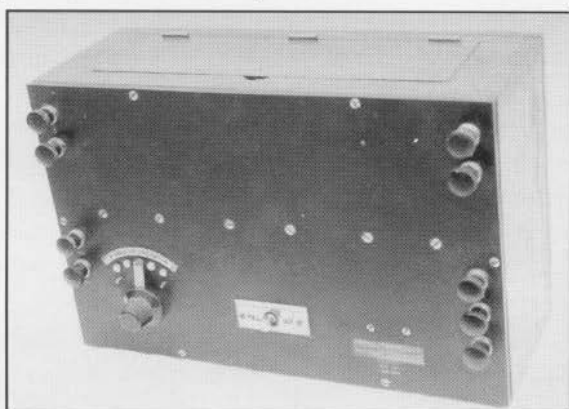
Cooperation between Northern Electric and the antecedents of the Victor Talking Machine Company go back at least to February 12, 1900, when C.F. Sise, then president of NE, noted in his log book that he had "Offered to Berliner, for the manufacture of his gramophone, 3 horsepower, room 15 ft. x 17.5ft., heat and light, at \$45.00 per month."<sup>13</sup> In 1900, the first gramophones in Canada were manufactured in space provided by NE in its Aqueduct Street building. The inventor was Emile Berliner, inventor of the flat disc records that were to replace the Edison cylinders and become the industry standard. Berliner was an immigrant from Germany to the US in 1870, and lived and worked in Washington and Philadelphia. He registered several patents, and formed the United States Gramophone Company in 1893, and then the Berliner Gramophone Company in Philadelphia in 1895. The latter



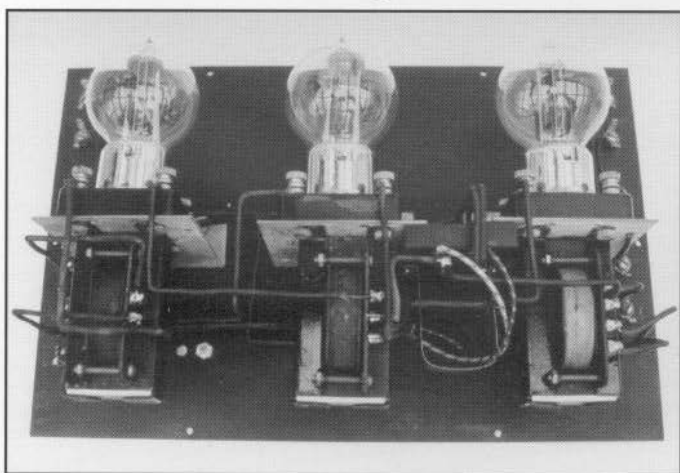
**Figure 20.** *Components side of the R-106 amplifier. Some of the wiring is not original.*



**Figure 21.** Schematic diagram of the R-106 amplifier.



**Figure 22.** The R-107 Loudspeaker Amplifier.



**Figure 23.** The components side of the R-107 amplifier. Some of the wiring is not original.

company was sued by the former over title to his inventions in 1900. As a result, Berliner folded the Berliner Company in the US and moved his operations to Montreal.<sup>14</sup>

The NE company also rented space to Berliner for his pressing plant, which manufactured flat disc records.<sup>13</sup> The Berliner Gram-o-phone Company built a factory of its own in 1908, and another in 1912, both on Lenoir Street in Montreal.

In 1924, Berliner Gram-o-phone was bought by the Victor Talking Machine Company of Camden, NJ. In 1929 Victor joined with RCA to become RCA Victor.<sup>14</sup>

Some other excerpts from the log books of C.F. Sise, president of NE:<sup>13</sup>

*February 25, 1920 – NE employees' Pension and Benefit Plan excluded claims resulting from fooling around, violent or riotous or immoral living.*

*September 22, 1920 – Alliance between Canadian General Electric Co. Ltd. and Marconi Wireless Telegraph Co. of Canada Ltd. and the Canadian Radio Corporation "no great fear of competition from the group ..."*

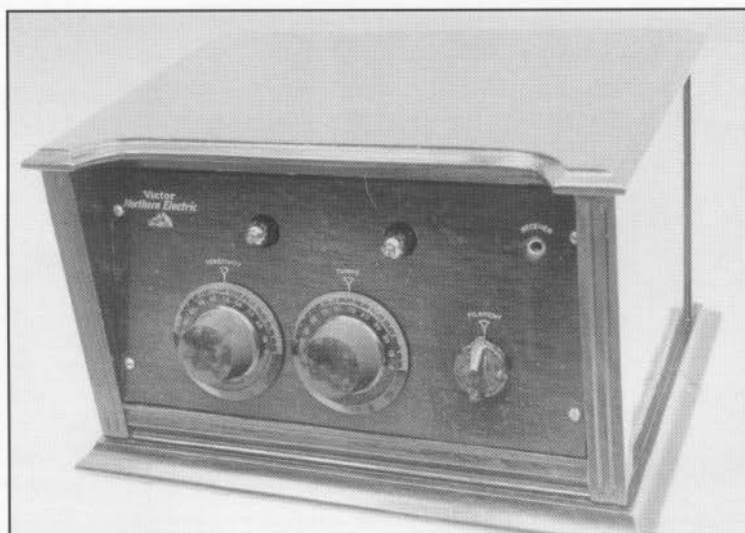
*December, 1922 – NE began manufacture of R2001 receiver set (higher amplification than R1000); plus short wave tuner (R2) and detector unit.*

*January 1923 – CHYC – 500-watt transmitter installed on 7th floor Shearer St. (NE broadcast station).*

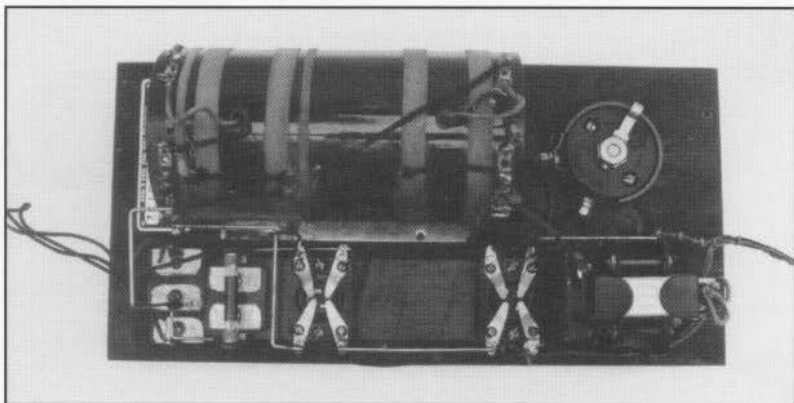
*April 1, 1923 – CHYC – first church broadcast.*

*April 24, 1923 - \$3,420 appropriated for one only single-six Packard touring car, seven passengers.*

*July 24, 1923 – NE appropriation for tools for mfr of R3 and R11 radio receiving sets; and R15, R105, R106, R107 amplifiers.*



**Figure 24.** Victor/Northern Electric type R-20 receiver.



**Figure 25.** *Components of the R-20 receiver.*

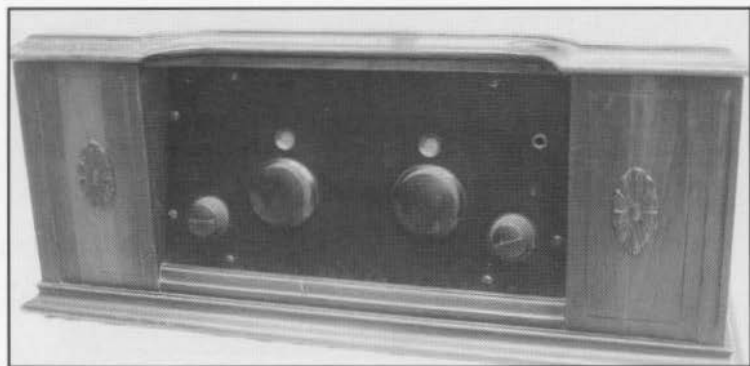
*April 23, 1925 – NE to execute contract with Victor Talking Machine Company of Canada Limited for handling by Victor of exclusive sales of NE radio receiving sets in Canada.*

*March 1, 1929 – Broadcasting station sold to La Presse Ltd. (CKAC) for \$89,000 on condition NE takes a certain amount of time; NE to use small 100-watt set to broadcast church services until new La Presse station operational.*

On April 23, 1925, NE reached an agreement with the Victor Talking Machine Company of Canada Limited of Montreal. They began production of a series of receivers to which NE apparently contributed the chassis and Victor the cabinet. Electronically these radios represented no particular advance for NE, which had been producing superheterodynes (the R-4). The first of these Victor/Northern Electric models was the R-20, a regenerative detector and amplifier using two R-215-A tubes and other NE parts. It was much like the R-12, and is shown in Fig. 24. Like the R-12 it was simple to operate, having only three controls. The components side is shown in Fig. 25. It looks rather like a Radiola III, don't you think? Its cabinet was somewhat more elaborate. It was described as having enough space inside to accommodate the batteries. A schematic was not supplied.

The Victor/Northern Electric type R-21 is a similar set using three R-215-A tubes in a regenerative circuit with two stages of audio amplification. Like the R-20, it claimed room inside the cabinet for the batteries, a little more convincingly this time because the cabinet was almost twice as long as the radio panel. A version of the R-21 was provided as a horizontal radio panel in a Victorola gramophone cabinet and was labeled type R-22. The same receiver provided as a vertical panel in an upright Victorola was labeled type R-23.

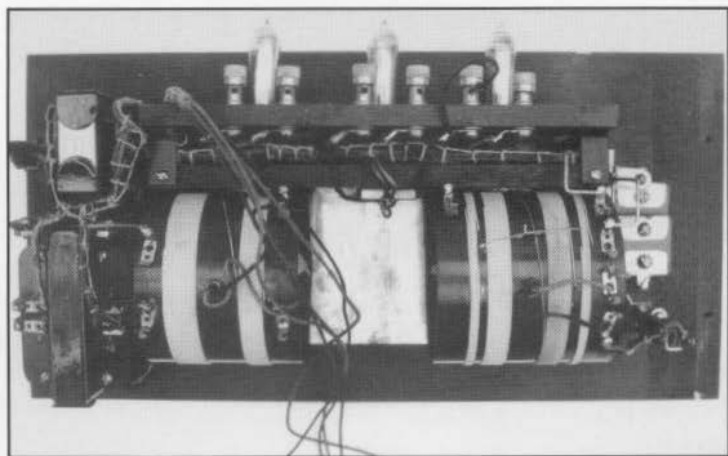
The Victor/Northern Electric type R-24 was again a three-tube regenerative set using the R-215-A with two stages of audio amplification. This time it



**Figure 26.** *Victor/Northern Electric type R-24 receiver.*

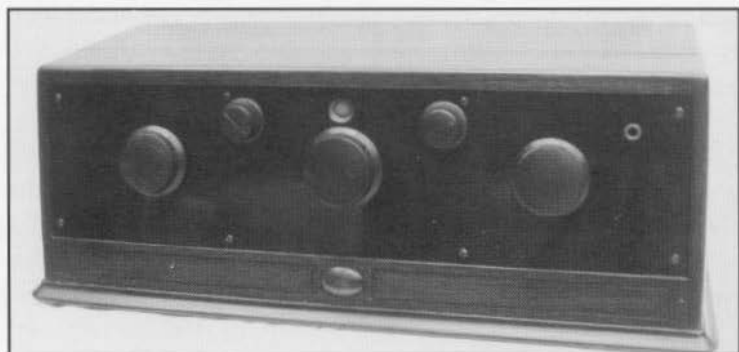
was in a slightly fancier box made of American Walnut (Fig. 26). The components are shown in Fig. 27. Again, it has Radiola III style coils. This was also the first broadcast receiver with which NE was involved that did not display the tubes through holes in the front panel. (The market seemed to be getting a bit more sophisticated in its tastes.) The type R-30 was a TRF receiver of the 1925 model year. It was a typical looking “three-dialer,” sharing some of the styling of the R-20 series of sets. It used five of the R-221-DX tubes, which were functionally equivalent to the ubiquitous R.C.A. UX-201A. Type R-31 was the horizontal panel version of the same set, designed to reside inside a Victorrola cabinet.

Following the R-4 and R-4-L superheterodynes, NE produced nine models with simpler circuits before attempting another superheterodyne. (That is, if they used model numbers sequentially which seems to have been approximately true.) The question is why? No one can tell us 70 years



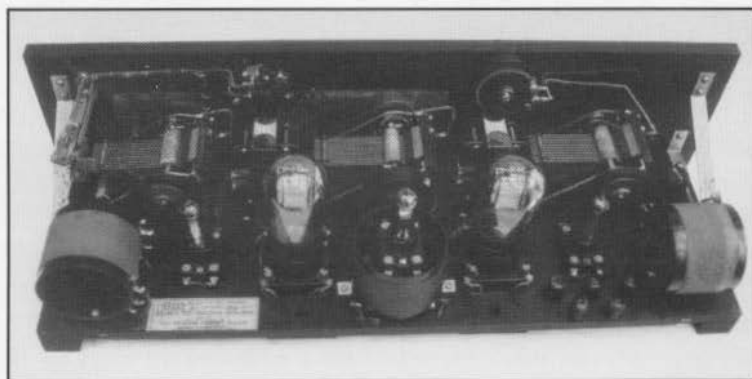
**Figure 27.** *Components of the R24 receiver.*

later. The R-4 superheterodyne appears to have sold quite well, judging by the number of surviving specimens. It was certainly expensive enough in comparison to its contemporary models. It seems possible that when reviewing the sales figures from 1922 to 1924, NE management decided to emphasize less expensive sets. However all of these models were bad neighbors in the sense of transmitting howls when not tuned carefully. Not since the R-3 had they protected the antenna against transmitting oscillations with a stage or two of rf amplification. The discretionary dollars would have also been scarcer in Canada. (Oh well, we were in the woods, remember?)



**Figure 28. (Above)** *Victor/Northern Electric type R-50 receiver.*

**Figure 29. (Below)** *Chassis of the R-50 receiver.*



Finally, in 1926 came another superheterodyne, the type R-40. This set used seven tubes and was styled very much like the type R-30 and the R-24 before it. For a little more money there was the type R-41, an eight-tube superheterodyne, apparently in the same cabinet. My bet is on an extra stage of audio amplification (see Table 3 for list prices and dates).

In 1925 there had been another anomaly, the type R-50. This was a five-tube set, a "three dialer," using three R-215-A tubes and two R-221-DX audio tubes (Fig. 28). The R-215-A tubes and the R-221-DX tubes are alternated in a single row inside the set (Fig. 29).

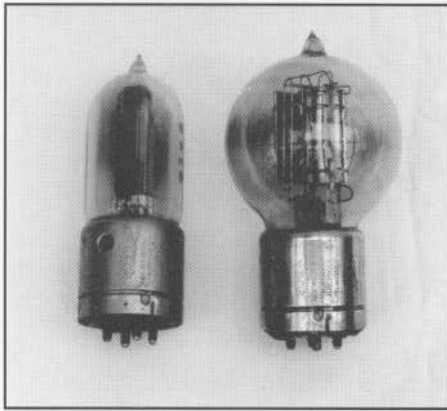
After 1926, NE and Victor appear to have gone their separate ways. The Victor Talking Machine Company made receivers under their own name for a time, and eventually presented models under the RCA Victor name, models which were the result of the merge of the parent companies in the United States in 1929. At NE, this point marked the end of receivers that were obviously designed by telephone company engineers and manufactured by the telephone industry. After spending a few seasons in disarray, they began to market receivers built by other companies, most notably American Bosch. The American Bosch Model 5A became the Northern Electric "Minaki" (1931) and the American Bosch 200-A became the NE 51 (1932), for example. NE later resumed the production of radios in a style which by then had become much closer to that of the rest of the industry. They used generically available parts and mass production methods.

Why did NE withdraw from the broadcast receiver market for the years between 1927 and 1930? One reason may have been that they lacked solutions to the electrical problems presented by alternating current (ac) operated sets. The telephone industry had progressed a little more slowly in solving these problems than had the broadcast radio industry. Western Electric had not begun to produce tubes with indirectly heated cathodes until 1929, and NE had, until that time, relied solely on Bell System tubes.<sup>15</sup> The receivers that NE obtained from American Bosch in the early 1930s were ac operated, suggesting that indeed they saw this feature as responding to a demand of the market.

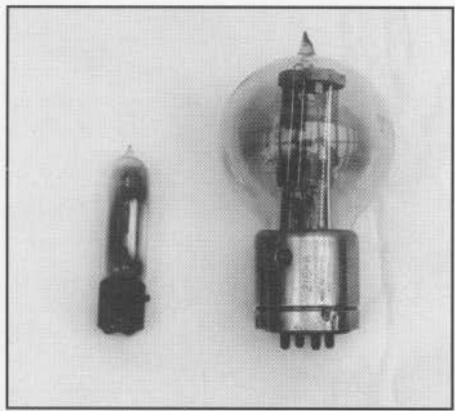
### **Northern Electric Radio Tubes**

NE first offered to the radio market what they conceded were telephone repeater tubes. In an early radio parts catalog, (July 1923), they listed two vacuum tubes for radio apparatus; the R-215-A and the R-208-A. The prefix "R" was not found on all NE tubes, and John Radcliffe (retired Curator, Bell Canada Historical Collection), suspects it may have stood for "radio" or "retail." Although the R-203-D was advertised in an August 1924 catalog, the four examples of this tube that I have seen are all marked "R-203-B, Made in Canada, Northern Electric Co., Limited."

The R-208-A was apparently the first NE tube actually manufactured in Canada. What follows is a table of NE radio tubes sold in Canada (Table 4). Corresponding to Table 4 are Fig. 30, 31 and 32. These tubes are either possibly or definitely designed by the Western Electric Company.



**Figure 30.** *R-203-B and R-208-A tubes.*

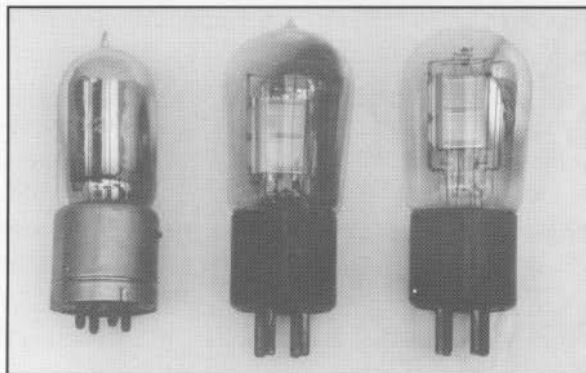


**Figure 31.** *R-215-A and R-216-A tubes.*

**Table 4. Northern Electric tubes of the 1920's that were sold as radio receiving tubes**

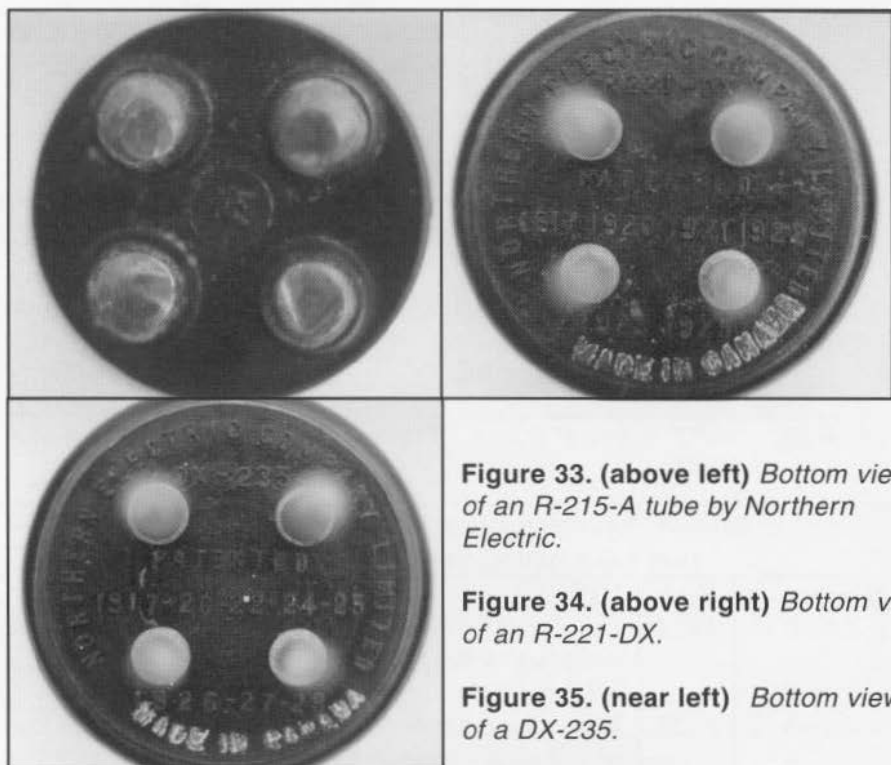
<u>Number</u>	<u>Year</u>	<u>Use</u>
R-203-D	1924	Developed for military use and sold surplus for amateur use after W.W. I. Listed in a NE radio parts catalog, 1924.
R-208-A	1922	First tube manufactured in Canada by NE for use in telephone repeaters (Feb. 3, 1922).
R-215-A	1922	Used extensively in the first NE receivers. Early development attributed to H.J. van der Bijl during W.W. I.
R-216-A	1922	Replaced the R-208-A. in NE power amplifiers in 1924.
R221-D or R-221-DX	1926	Equivalent to RCA UV-201A.
DX-235	1926	Equivalent to RCA UX-201A, used in R-4-L, R-50 etc.
		Equivalent to RCA UX-201A.

Note: The information in this table comes largely from Magers<sup>15</sup> and Tyne<sup>16</sup>.



**Figure 32.** *R-221-D, R-221-DX and R-235-DX tubes.*





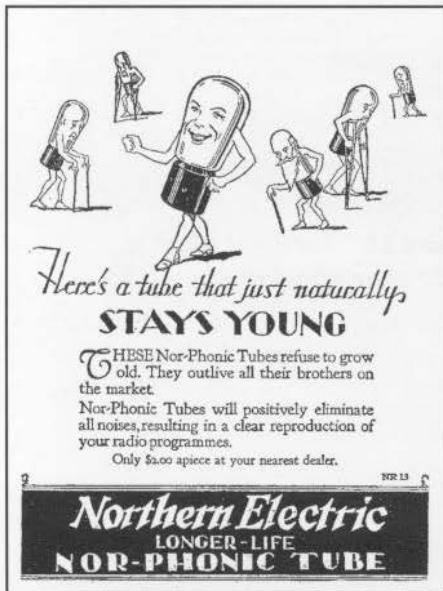
**Figure 33. (above left)** Bottom view of an R-215-A tube by Northern Electric.

**Figure 34. (above right)** Bottom view of an R-221-DX.

**Figure 35. (near left)** Bottom view of a DX-235.

The R-215-A tube was widely used in domestic radios in Canada, both in factory built radios<sup>17,18</sup> and in the home builders market.<sup>19</sup> It is interesting because although the early development was attributed to H.J. van der Bijl, a South African radio pioneer working for Western Electric in New York,<sup>20</sup> a popular Canadian radio magazine attributed it to W.B. Cartmel, a NE engineer.<sup>21</sup> This “fact” appears to have escaped the attention of both Gerald Tyne<sup>16</sup> and John Stokes.<sup>22</sup> It is curious that Cartmel would have been represented this way. Although charlatans were certainly in existence at that time in Canada as elsewhere, the telephone industry was particularly subject to litigation, had their own legal department, and one presumes would not have looked favorably on “small” and unnecessary legal transgressions. Cartmel, also guilty of publication of the R-4 receiver schematic and design, sounds like a black sheep, at least.

Today there are numerous 215-A tubes in collectors’ hands. The ones made by NE typically do not have the number R-215-A printed on them. They do have a small circular NE logo molded into the bottom of the bakelite base between the button contacts (Fig. 33). The Canadian 216-A is referred to as either the 216-A or the R-216-A. It may also be true that they were listed as R-216-A in the catalogs, but marked 216-A on the nickel-plated brass base of the tube. This is based upon my experience, but I can think of no reason why it should be so.



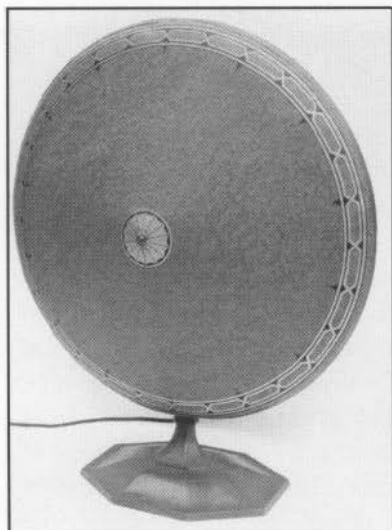
**Figure 36.** Print ad for a NorPhonic tube, from the *Western Home Monthly*, 1925.

The NE type 221-D comes in two versions (Fig. 32). First there is the R221-D which has a UV base and is the earlier of the two. NE apparently had no stock of metal bases stamped R221-D. The six that I have seen have all had the tube number ground off of the side of the base, and painted on the side of the glass. Judging from the patent dates remaining on the metal, the bases might have been originally intended for R-203-B tubes. The newer R-221-DX tubes have a UX

bakelite base with tube numbers and patent dates molded into the bottom (Fig. 34). The “Made in Canada” mark on these tubes was separately applied in silver paint, raising the possibility that they were made by Western Electric, rather than just designed by them. The DX-235 was another RCA UX-201A equivalent made about the same time, but it had a tipless bulb with the evacuation connection on the bottom of the tube (Fig. 32, 35). It was advertised as a “Nor-Phonic” tube (Fig. 36). There was not enough information supplied in the advertising to indicate what design improvements in the tube accounted for the advertising claims. The DX-235 originally sold for \$2.00, but in 1929 they were considered surplus stock and were offered in the Eaton’s department store radio catalog for \$0.79, delivery included. The age of the 201-A was over.



**Figure 37.** Sample of Northern Electric tube cartons.



**Figure 38.** *Northern Electric R540 cone speaker.*

Some of the early NE tube cartons are shown in Fig. 37. The DX-235 is shown as the “Nor-Phonic” tube. Peanut tube cartons are shown from both the NE and the Victor/Northern Electric eras of production. For comparison a NE 12SK7GT/G carton is shown from more recent times. This tube, produced in the 1940s, is marked “product of” NE. It is not clear whether it was a product of their manufacturing or of their warehousing operations, but it looks much like an RCA tube. Canadian General Electric and Canadian Westinghouse were the predominant radio tube manufacturers by this time, and NE radio tubes were almost unheard of.

### Speakers

Northern Electric headphones and speakers were normally very close in design to those sold by Western Electric. Headphones came in models R-6A, R-6B (both 2500 ohms), R-6C, R-6D, R-6E (all 3000 ohms), R-7, R-8 (both 1250 ohms), R-10 and R-10A (both 3000 ohms). Not being a student of subtle differences in headphone design, I would say that they look very similar to each other. Models R-7 and R-8 are single ear pieces.

The NE R518 Loudspeaking Receiver was an exact copy of the Western Electric 518W horn, except for the labels. The advertising stated that the NE loudspeakers were designed by the Western Electric Company, New York. The NE R500 speaker was described as a Library Phone, and was similar in appearance to the Western Electric Shawphone. However the R500 stood 19.5 inches high, whereas the Shawphone was 14 inches. A third NE horn of the period was the R6900 Loud Speaker, advertised with the R-24 receiver. It came with a rectangular metal base which held the

driver, and with a horn above. The arrangement appears like a Hart and Hegeman "After Dinner Speaker," but is different in detail and is finished in medium brown. Where the Hart and Hegeman base is 5" x 7", the NE base is 4.25" x 5.75". No Western Electric equivalent has been found.

The NE paper cone speaker, model R540, was equivalent in design to the Western Electric model 540AW. It is shown in Fig. 38 and is more decorative than its Western Electric cousin, with its pattern created in gilt paint.

### Summary and Conclusion

The NE company saw a revenue opportunity with the coming of broadcast radio, and jumped in vigorously at the first. Still it amounted to a small part of the NE manufacturing business. Their early designs were a strong reflection of Western Electric engineering practices of the time. Some of the equipment was designed with direct help from Western Electric and some was evidently designed by NE engineers, one of whom was Cartmel.

In the late 1920s the telephone industry style of engineering was less appropriate for the domestic market, with the high reliability design causing excessive costs. Cabinet designs in the marketplace were beginning to be more appealing, and NE addressed this change for a while by teaming up with the Victor Talking Machine Company of Canada Limited. By 1927 NE was again looking for a change in direction. There may have been some pressure from Victor in the US to sever the Victor/Northern Electric collaboration, but there appears to be no record of this.

Demand for ac-operated receivers was growing. Up until 1926, NE receivers relied entirely on Bell System engineering, and Western Electric did not develop their first ac-operated tubes until 1929. NE ceased manufacture of broadcast receivers in 1926, and then reverted to its role as seller of third party radios in 1931. American Bosch was one such supplier, and their radios were sold in Canada with escutcheons marked NE.

AT&T was prevented by their agreement with RCA from competing in the broadcast receiver business. Perhaps the early broadcast receiver production of NE gives us some idea of how AT&T might have proceeded in the early years if the Radio Group agreement had been negotiated differently.

### References

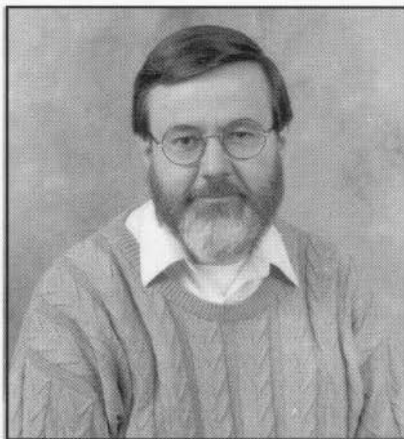
1. Lewis, T.S.W. *Empire of the Air: The Men Who Made Radio*. New York, NY: HarperCollins publishers, 1991.
2. Personal communication, John Radcliffe, Curator (retired), Bell Canada Historical Collection, Montreal, Quebec, Canada.

3. Grosvenor, E.S. and Wesson, M. Alexander Graham Bell: *The life and times of the man who invented the telephone*. (Chapter 3). New York, NY: Harry N. Abrams, Inc., 1997.
4. McFarlane, L.B. Preamble to a reply to the A.T. & T. Historical Librarian on the history of the Northern Electric Company, Ltd., 1935. Bell Canada Historical Collection, Montreal.
5. Powers of the Northern Electric and Manufacturing Company, Limited, as contained in Letters Patent, 13th December, 1895. Bell Canada Historical Collection, Montreal.
6. McFarlane, L.B. Northern Electric and Manufacturing Company, Document No. 24095, 1938. Bell Canada Historical Collection, Montreal.
7. Canadian Interests Pool Patents for Good of Radio. *The Toronto Star*, August 14, 1923.
8. What Northern Electric means to Bell Telephone. *The Financial Times*, Toronto, December 12, 1923.
9. *Electrical Supplies General Catalogue*, No. 5. Northern Electric Company Limited, 1925
10. Williams, R.O. The Atwater Kent Radios. Chapter 3. *The AWA Review*, 1999; 12, 27-57.
11. Douglas, A. *Radio Manufacturers of the 1920's*. Vol. 3. Vestal, NY: The Vestal Press, Ltd. 1991.
12. Cartmel, W.B. What is a super heterodyne receiver? *Radio News of Canada*, 1925; 3(7), 14-16 & 56-57.
13. Newman, P.C. Northern Telecom: Past present future. Mississauga, ON: Northern Telecom Limited, 1995.
14. Website of the Berliner Museum, Montreal QC. [www.contact.net/berliner/](http://www.contact.net/berliner/) Dec. 16, 1999.
15. Magers, B. *75 Years of Western Electric Tube Manufacturing*. Tempe, AZ: Antique Electric Supply, 1992.
16. Tyne, G.F.J. *Saga of the Vacuum Tube*. Indianapolis, IN: Howard W. Sams & Co., Inc., 1977.
17. Murray, R.P. "The Voice of the Prairie": A Brief History of W.W. Grant (1892-1968). *The Old Timer's Bulletin*, Antique Wireless Assn. 1992; 33(3), 16-19.
18. Allen, B. The Mercury Super Ten. *The Old Timer's Bulletin*, Antique Wireless Assn. 1985; 26(3), 18-19.
19. Murray, B. Eaton Single Circuit Set, 1923. *Antique Radio Classified*, 1994; 11(8), 4-5.
20. Vermeulen, D.J. The beginnings of vacuum tube radio at Western Electric. *The AWA Review*. 1998; 11, 104-149.
21. Cartmel, W.B. The peanut tube and how to get the most out of it. *Radio News of Canada*, 1924, 3(1), 24.
22. Stokes, J.W. *70 years of radio tubes and valves*. Vestal, NY: The Vestal Press, 1982.

## Acknowledgments

The author wishes to thank John Radcliffe (curator, retired), Lise Noel and Lorraine Croxen of the Bell Canada Historical Collection, Montreal for their help on my several visits. John not only provided much information but also proofread a draft of this manuscript. Their Collection includes the Northern Electric Collection. I also wish to thank Fred Hammond (deceased) and the Hammond Museum of Radio, Guelph, Ontario. Collectors Robert MacIntyre of Winnipeg, Lloyd Swackhammer of Alma, Ontario, and Lew Bodkin of Toronto also supplied useful historical information.

**Robert P. Murray**  
Winnipeg, MB, Canada



Bob was born in 1944 in Summerside, Prince Edward Island, Canada. Bob's interest in radio goes back to the things his father taught him about it, and of course to the building of his first crystal set. His father had been a ham "before the war" by which he meant in about 1913. Bob's interest in *antique* radios began when a friend in graduate school started an antique store in Winnipeg, and sold him a Phenix Ultradyne with a horn speaker. Then his wife, Eileen, came home after a weekend in rural Manitoba with a Northern Electric model R-4. From his father Bob knew what a "peanut" tube was, and he proceeded to get more interested in the hobby.

Like many collectors he at first emphasized diversity in his collection. He attended the Minnesota regional meetings of the AWA where Joe Pavek would demonstrate his early spark apparatus, and members would offer help and advice to fledgling collectors. From there he learned about the annual meetings in Canandaigua. Gradually his collection shifted to emphasize broadcast receivers made in Canada in the 1920s. He participated in AWA contests and was further motivated by winning the Bruce Kelley OTB Award in 1992 and again in 1995.

Bob holds a PhD in experimental psychology, and currently is Professor, Community Health Sciences, Faculty of Medicine, University of Manitoba. At work there is not an antique radio in sight, but there is ample opportunity for Bob to practice his scientific writing style.

Bob worked briefly for Bell Canada headquarters in Montreal while Eileen completed her residency in Dermatology, from 1972 to 1974. He remembered the Bell historical display he had visited as a child, and he still has friends in the head office who have eased his access to the Bell archives. On his first visit there, one of the staff said, "There is some fellow in Winnipeg writing about radio history in the OTB. Do you know him?" The Northern Electric archives are held by the Bell Historical Collection, and Bob has been working on and off on this story of Northern Electric radio for more than ten years.

Correspondence may be sent to Bob Murray, 3216 Assinboine Ave., Winnipeg, MB, Canada R3K 0B1. E-Mail [rmurray32@home.com](mailto:rmurray32@home.com). Photo credits: All photos were taken by the author of items in the author's collection.

# MARCONI v. BRITISH RADIO TELEGRAPH AND TELEPHONE COMPANY : THE PATENT CASE THAT CHANGED THE WORLD

**Graeme Bartram**  
New South Wales, Australia

In recent years the Marconi versus Lodge debate on the origins of wireless has received renewed interest.<sup>1</sup> Yet how the Marconi 7777 tuning patent achieved commercial pre-eminence ahead of the patents of Lodge and others has had far less attention. This paper sets out to demonstrate that the decision of Mr. Justice Parker in *Marconi v. British Radio Telegraph and Telephone Company*<sup>2</sup> in 1911 on the 7777 patent was pivotal to the Marconi Company obtaining commercial dominance of the growing market opportunities in wireless telegraphy. This is shown through a detailed examination of the background to the court case, the men behind it and the commercial impact the decision had on world-wide wireless-telegraphy development. On this basis it is argued that the case proved to be a watershed in the history of wireless telegraphy, because it gave the Marconi Company the commercial leverage it required to dispose of both large and small competitors, and also wrote what was to become the conventional view of the prehistory of wireless.

## **The British Radio Telegraph and Telephone Company**

The British Radio Telegraph and Telephone Company (hereafter BRT & T Co.) was a small privately owned company which was first registered in July 1909. Capitalisation of the company was set at £15,000, £10,000 of which was working capital. The BRT & T Co. was established to market the 'Balsillie System' of wireless telegraphy,<sup>3</sup> and was headed by the young Australian engineer and inventor John Graeme Balsillie, who had lodged his first successful wireless telegraphy patent in 1905.<sup>4</sup>

Mr. Balsillie had arrived in the United Kingdom in 1903 and joined the British de Forest Wireless Syndicate as an engineer in August 1905, gaining experience on the construction of the Cullercoats wireless telegraphy station between February and June 1906.<sup>5</sup> In September 1906 the British de Forest Wireless Syndicate was absorbed by the Amalgamated Radio-Telegraph Company, Ltd. with the new company acquiring the Syndicate's undertakings and patent rights.<sup>6</sup> Balsillie joined the new company and completed the installation of the wireless telegraphy equipment at Hunstanton and Skegness in England, employing the de Forest system.<sup>7</sup>



The Amalgamated Radio-Telegraph Company, Ltd. provided Balsillie with the opportunity to work in both Europe and Asia on a variety of wireless telegraphy systems. He gained valuable experience acting as the company's Chief Engineer in Russia between December 1906 and August 1907 demonstrating the de Forest system, and he spent two periods in the Berlin laboratories in 1907 and 1908, working on improvements to the Poulsen system. He was also Amalgamated's Chief Engineer in China when the company was voluntarily wound up after a meeting of creditors in December, 1908.<sup>8</sup>

After the collapse of the Amalgamated Radio-Telegraph Company, Ltd., Balsillie spent the early part of 1909 developing his own system of wireless telegraphy. When the BRT & T Co. was formed later that year Balsillie was joined by London solicitor Walter Hudson Matthews (Chairman), merchant Frederick Ramon de Bertodano, engineer Tom Vincent Smith and George Pascoe Grenfell (Secretary). Balsillie has been variously described as the BRT & T Co.'s Managing Director, Technical Director and Chief Engineer.<sup>9</sup>

Field tests of the Balsillie System commenced on the Stancliffe Moors in Derbyshire on 22 October 1909. The experiments were conducted from a temporary station consisting of two masts 70 feet high with the receiving apparatus housed in a temporary wooden hut. Signals were received from the BRT & T Co. offices in London, a distance of 147 miles, using a ¼ kW primary energy source. The station was also able to receive signals from the Atlantic steamers of North German Lloyd Company at a distance estimated to be 700 miles.<sup>10</sup> While the BRT & T Co. considered these experiments to be a great success, Tom Vincent Smith was quick to correct more exaggerated statements regarding "a £60 wireless station [that] speaks with Germany."<sup>11</sup>

Active commercial promotion of the system commenced with the publication of 'Wireless Telegraphy-The Balsillie System' by the BRT & T Co. in October, 1909<sup>12</sup> and the installation of a demonstration set at the Earl's Court School of Telegraphy in London.<sup>13</sup> This led to interest both within Britain and overseas, with reported sales to France and Spain later occurring.<sup>14</sup>

The Australian Government took a special interest in the Balsillie system as it had issued tenders for the erection of two coastal stations in Sydney and Fremantle in October, 1909.<sup>15</sup> Initial contact was made by George Pascoe Grenfell of the BRT & T Co. with the Australian High Commission in London in early November. This was followed up by a private demonstration for Australian Government representatives which took place on 3 December 1909. This was held at the London offices of the BRT & T Co. using the Post Office's wireless telegraphy station at Hunstanton, which had been temporarily installed with the Balsillie system. After initial frustrations caused by storm damage to the Hunstanton mast, communications were established at 105 miles.<sup>16</sup>

On 14 December 1909 the BRT & T Co. exhibited the Balsillie System at the fifth annual Royal Physical Society Exhibition held at the Imperial College of Science and Technology in London. The Electrician subsequently published the first full journal description of the Balsillie system equipment which was displayed at the Exhibition, noting "the apparatus is of substantial construction and high-class finish throughout."<sup>17</sup>

The BRT & T Co. quickly capitalised on the public exposure of the Balsillie system and on the growing opportunities in maritime wireless telegraphy. In January, 1910 apparatus was fitted to the Bowles Bros. tramp steamer "Nonsuch."<sup>18</sup> Later in 1910 the equipment aboard the "Nonsuch" reportedly transmitted her name from 15 miles south of Cape de Gata in Spain to the wireless station at North Foreland, a distance of 940 nautical miles.<sup>19</sup> The company also intended to establish onshore wireless facilities, with George Pascoe Grenfell visiting the Swansea area in February, 1910 in search of a suitable wireless telegraph station site.<sup>20</sup>

### **The Balsillie System**

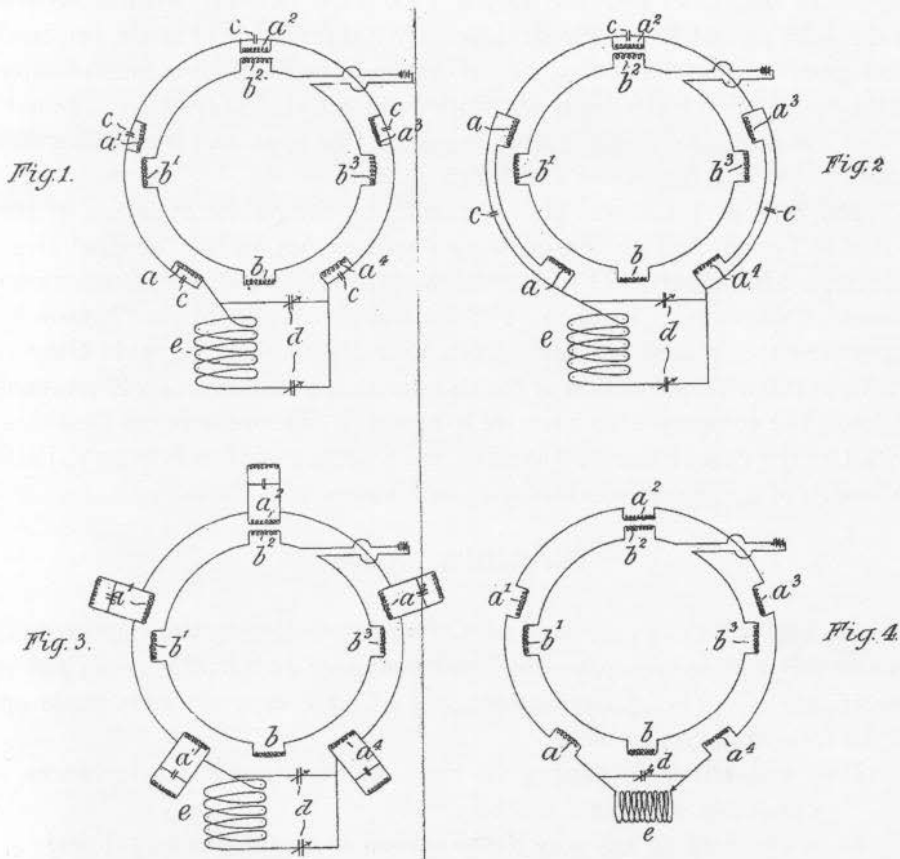
The BRT & T Co.'s Balsillie system of wireless telegraphy was characterised as a weakly damped wave system,<sup>21</sup> and was based on Balsillie's own patent specifications.<sup>22</sup> The apparatus consisted of three separate units made up of the following components :

- a) a transmitter containing the transformer, adjustable inductances, condenser and spark discharger;
- b) a transmitting key which also served as an antenna switch and
- c) a receiver consisting of the detector, an adjustable primary inductance, an adjustable secondary inductance, an adjustable secondary condenser and a variable coupling control.

### **Transmitter**

The transmitting apparatus operated according to the same general principles as other systems of wireless telegraphy of the time whereby a high frequency alternator energised a transformer which charged a plate glass condenser, which in turn discharged through a spark gap and variable inductance, to which the aerial wire and earth were connected. The high-frequency alternator (see Fig. 1)<sup>23</sup> gave a periodicity of 1500 cycles per second. The use of this frequency was intended to produce a clear musical note which could be more easily detected at great distances.

The transformer windings were proportioned to raise the voltage of the primary circuit to a potential of 15,000 volts at the condenser terminals. The condenser itself consisted of  $\frac{1}{4}$ -inch glass plates covered on one side by tin foil and on the other by paraffin wax. These plates were mounted on



**Figure 1.** Balsillie's High Frequency Alternator Patent of 1908  
 Source: The Patent Office.

top of each other, then bound together with insulating tape and embedded in paraffin wax in a mahogany box. The capacity of the condenser for a 1/4-kW station was 0.002 mfd.

The spark discharger for the system was of novel construction (see Figs. 2 and 3).<sup>24</sup> In his initial patent application Balsillie had concluded that, where an alternating current generator of comparatively low frequency (i.e. 60 to 120 cycles per second) was employed, the spark produced by a conventional spark gap resulted in a large amount of arcing. Balsillie's concept was to break up the spark discharge in such a manner that a musical note was produced at the receiver. The aim of the device was to produce a musical note independent of the alternator's low frequency.

In order to achieve this Balsillie designed a spark discharger consisting of a brass-toothed wheel which was kept in constant rotation between the electrodes joining the condenser and inductance. This gap was capable of

Fig. 1.

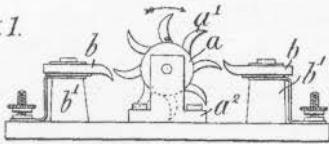
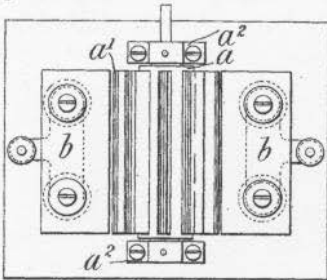


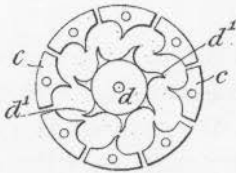
Fig. 2.



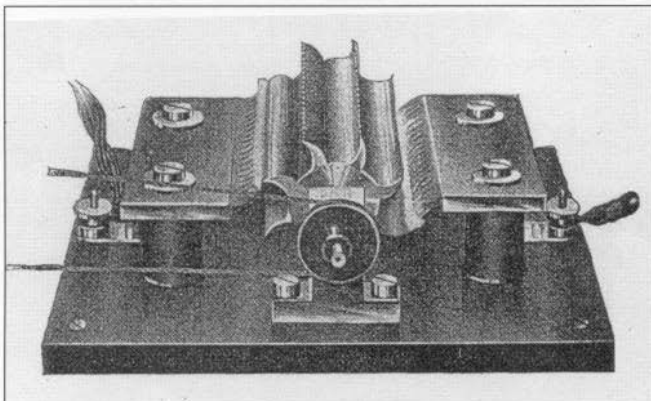
**Figure 2.** Balsillie's Spark Discharger Patent of 1909.

Source: The Patent Office.

Fig. 3.

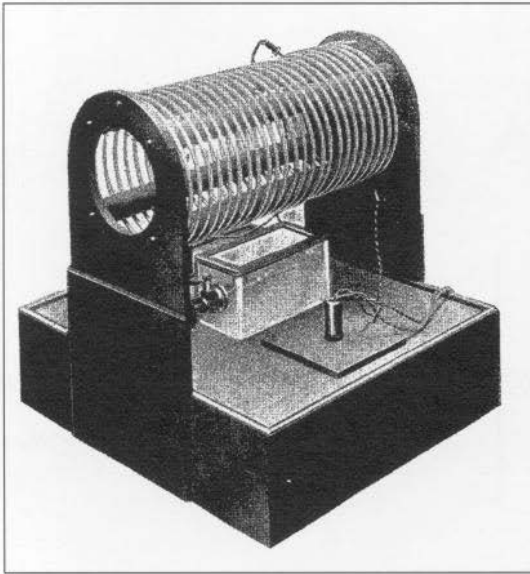


interrupting the discharge from the condenser from 300 to 1,500 times per second. It was claimed that the rotation of the gap produced a complete absence of arcing and led to the greater efficiency of the transmitting apparatus. Figures quoted by Balsillie in *The Electrician*<sup>25</sup> indicate that the spark length required for a 1-kW station was 1/64 inch and for a 2-kW station was 1/32 inch. Little heating was experienced at the spark gap even after considerable operating time.<sup>26</sup>



**Figure 3.** Spark Discharger.

Source: *The Electrician*, Vol 64, January 1910



**Figure 4. Tuning Inductances**  
*Source: Australian Archive*

Independent tests undertaken by Charles Bright on the spark discharger on behalf of the Australian Government also identified a high efficiency in radiated energy. Bright drew this conclusion after observing the energy both at the transformer and that sent out at the antenna while the transmitting key was continuously depressed.<sup>27</sup>

The tuning inductances (see Fig. 4) consisted of twenty four turns of silver-coated copper tubing on an air core. The inductance for the oscillating circuit was divided into two parts, one of sixteen turns and one of eight turns. The wavelength that was obtained by connecting the condenser through the spark gap to the two terminals of the smaller inductance section was between 200 and 750 metres. The wavelengths for the larger section were up to 1,780 metres, while the wavelengths for the inductance as a whole was 2500 metres. The complete range of tuning was therefore 200 to 2500 metres. The four means of coupling employed were :

- a) an oscillating circuit and an aerial wire directly coupled to the oscillating turns;
- b) an inductive coupling by which the energy of the oscillating circuit is transmitted to the aerial wire circuit by transformation;
- c) a direct coupling with a re-acting circuit and,
- d) an inductive coupling with a re-acting circuit.

These alternative methods of coupling were arranged to meet the requirements of the International Radio Telegraphic Convention.<sup>28</sup>

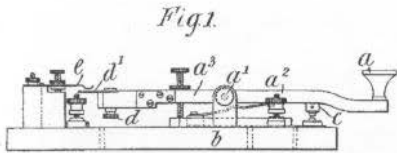


Fig. 1.

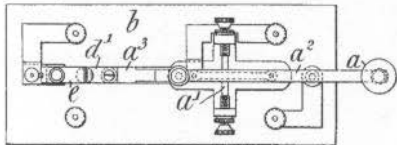


Fig. 2.

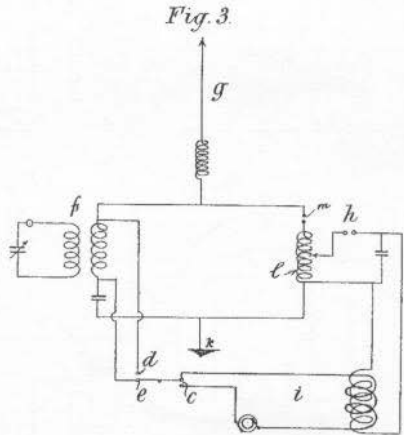
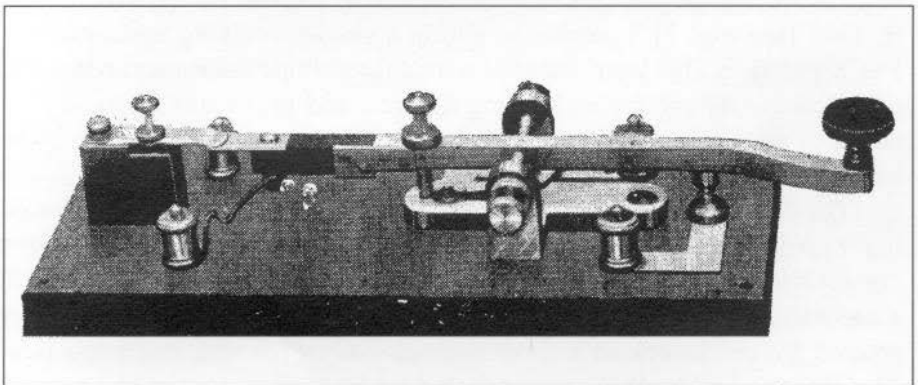


Fig. 3.

**Figure 5.** Balsillie's Morse Key Patent of 1909.  
Source: The Patent Office.

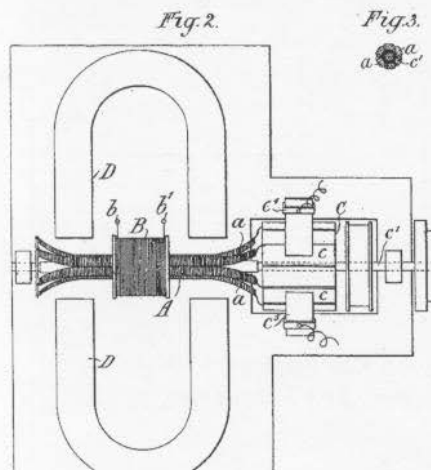
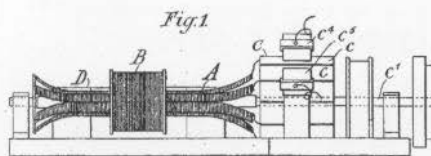
### The Morse Key

The design of the Morse key (see Fig. 5 and 6)<sup>29</sup> embodied both a transmitting contact and an automatic receiver cut-out in a single apparatus, thus eliminating the manual antenna and detector switches normally required. As a result the transmitting operator's receiver was only out of circuit when the key made contact and therefore allowed the receiving operator to remain in operative connection during transmission.<sup>30</sup>



**Figure 6.** Morse Key

Source: Australian Archive



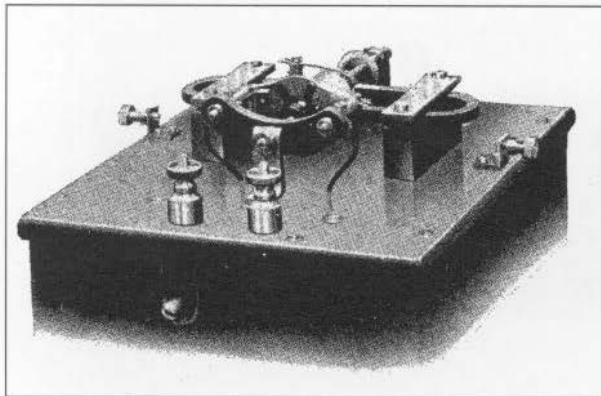
**Figure 7. Balsillie's Detector Patent of 1905.**  
 Source: The Patent Office.

## Receiver

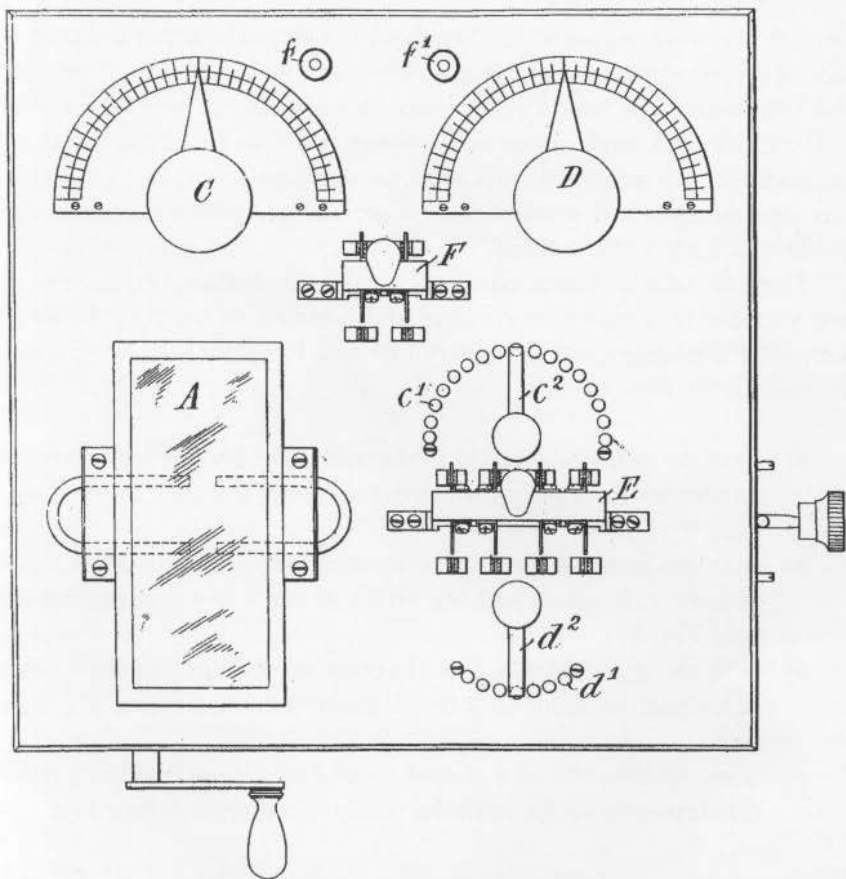
The interference reducer was an energy-absorbing highly-damped closed oscillatory circuit which contained a fixed capacity and a variable inductance. The inductance was constructed of high resistance wire and was connected across the terminals of the capacity. The oscillatory circuit that was created was tuned to the frequency of the oscillations to be eliminated, resulting in rapid absorption.<sup>31</sup>

The receiving equipment contained an earlier detector patented by Balsillie in 1905 (see Fig. 7).<sup>32</sup> combined within a single receiving apparatus (see Fig. 8 and 9).<sup>33</sup> This later patent provided for a single instrument consisting of a detector, telephone and tuning devices, and the means for tuning the aerial to any desired frequency, and also for preventing the receiver from being disturbed by other oscillations.

The detector was an extremely sensitive magnetic hysteresis transformer made up of six cores of soft iron wire, each wound with a number of insulated copper wires making up the primary winding. These were overwound with a secondary winding connected to a telephone or other receiver. This was rotated by clockwork in a fixed diametrically opposing magnetic field. The antenna and earth were connected by brushes to two of the primary windings at the moment they traversed the critical part of the field. If oscillations were passing through the primary winding at this time the hysteresis of

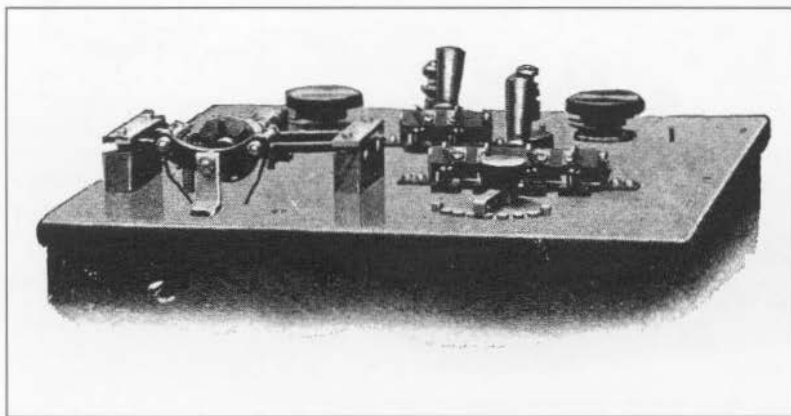


**Figure 8.** *Detector*  
 Source: Australian Archive



**Figure 9A.** *Balsillie's Receiver Patent of 1909.*  
 Source: The Patent Office





**Figure 9B.** *Receiver.*

*Source: The Australian Archive*

the soft iron core was much reduced. Clicks were therefore induced in the secondary winding and became audible on the telephone. The detector was automatic in its action and required no adjustment beyond the winding of the clockwork each six or seven hours. Charles Bright saw that one of the principal advantages of this detector was that it was not influenced by surrounding electrical disturbances, a serious problem where atmospheric conditions were unfavourable.<sup>34</sup>

The tuning device consisted of two variable condensers, two main switches, two variable inductance controllers and a means of varying the coupling between the primary and secondary circuits. Four methods were available to connect the detector, viz :

- a) with the detector directly in the aerial circuit and with the primary condenser in shunt with the detector and primary inductance (see Fig. 10),
- b) with the detector directly in the aerial circuit and with the primary condenser in series with the aerial, detector and primary inductance (see Fig. 11),
- c) with the detector in a closed secondary circuit and the primary condenser in shunt with the primary inductance (see Fig. 12) and,
- d) with the detector in a closed secondary circuit and the primary condenser in series with the primary inductance (see Fig. 13).

These arrangements produced a receiving wavelength range of 100 to 4,500 metres.<sup>35</sup>

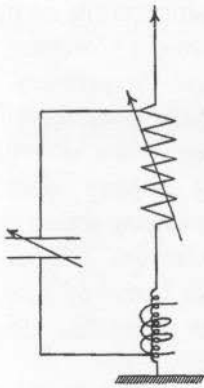


Figure 10



Figure 11

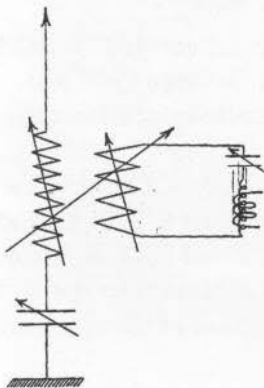


Figure 12

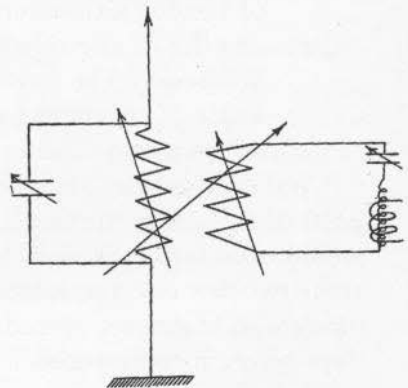


Figure 13

Figures 10-13. Charles Bright's drawings of Detector operation.  
Source: Australian Archive

### The Case

Until 1910 the Marconi Company had shown some reluctance to take action against alleged patent infringements of master patents.<sup>36</sup> However the appointment of Godfrey C. Isaacs as the joint Managing Director of the Marconi Company in January, 1910 was to signal a change of fortune for the BRT & T Co. and other competing wireless companies.

The BRT & T Co. would have been a logical target for the Marconi Company. It had a low capital base unlikely to withstand a lengthy patent case, and a victory by the Marconi Company would have sent a strong

signal to other small and medium-size companies marketing competing wireless telegraphy systems. The stakes for the Marconi Company were high. A win against the BRT & T Co. would confirm the primacy of the 7777 patent. A loss, on the other hand, would potentially open the wireless telegraphy market to even more competitors at a time when shareholders were yet to see sustained profits from the Marconi Company operations.

On 2 March 1910 the Marconi Company commenced action against the BRT & T Co. for alleged infringement of the Marconi 7777 and two other patents<sup>37</sup> in the Chancery Division of the High Court of Justice. In their Statement of Claim the Marconi Company (as plaintiffs) identified the particular alleged breaches of patent as:

- a) the publication in January or February 1910 by the defendants of a pamphlet entitled 'The Balsillie System of Radio-Telegraphy,'
- b) the exhibition and offer for sale of apparatus at the Physical Society of London Exhibition on 14 December 1909,
- c) an offer of sale of apparatus by a pamphlet entitled 'Wireless Telegraphy-The Balsillie System' circa October 1909 and,
- d) a sale of apparatus to Bowles Bros. installed circa January, 1910 on the tramp steamer "Nonsuch."<sup>38</sup>

Walter Matthews' law firm advised the BRT & T Co. that the legal costs of the case in the first instance would be at least £3000. This amount would even further stretch the now undercapitalised BRT & T Co. As a result two new directors joined the BRT & T Co. in November, 1910. These, along with Matthews, agreed to underwrite the costs of the case just three days before it commenced.<sup>39</sup>

### **The Marconi Case**

Formal hearings commenced before Mr. Justice Parker on 12 December 1910. The Marconi Company had put together a formidable team of three leading patent counsel to represent their interests. John Meir Astbury KC had specialised in patent litigation since 1905 while Arthur James Walter KC was a patent lawyer who had built his career specialising in cases requiring a detailed knowledge of chemistry and electricity. The third member of the team, James Hunter Gray, held a Bachelor of Science degree and was a member of the Institution of Electrical Engineers. During his early career Gray had come under the influence of Sir William Thomson (later Lord Kelvin).<sup>(40)</sup>

There were essentially two legs to the Marconi Company's case, each of which was of equal importance. Firstly, Astbury had to draw the Court's attention to the actual achievements of the Marconi system, namely that an integrated system of wireless telegraphy had been consistently developed by Marconi since 1896. Secondly, the 7777 patent needed to be distinguished

from other wireless telegraphy developments from a technical and legal point of view. The argument was to be a powerful one. Not only had Marconi developed a series of linked patents representing a system of wireless telegraphy, but that system had produced practical and commercial results.

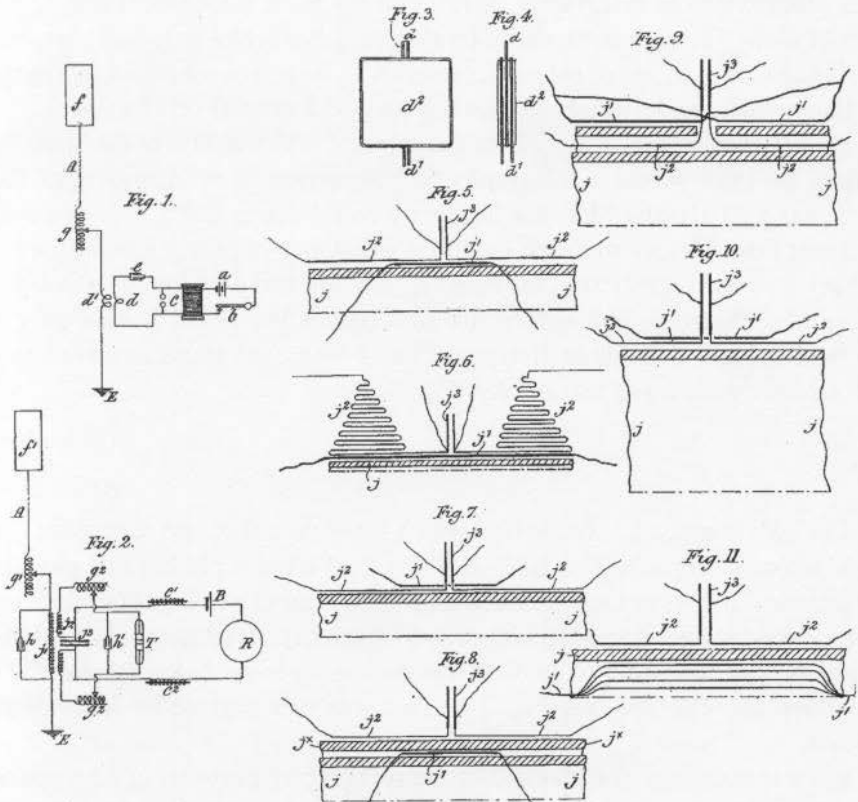
By 1910 few would have doubted the practical achievements of the Marconi system. In 1896 wireless telegraphy had struggled to send messages 1¾ miles, yet by 1910 the Marconi Company could claim that a message had been sent from Clifden to South America, a distance of nearly 6,000 miles.<sup>41</sup> Astbury was quite explicit in his claims; “No one had developed ‘wireless’ before Mr. Marconi, and before his first patent [in 1896] it was only a practical success over short distances”<sup>42</sup> and “Marconi alone achieved any real success with wave telegraphy.”<sup>43</sup>

### The 7777 Patent

The patent question would be a much more complex one to resolve for the Marconi Company. The BRT & T Co. had cited a plethora of patents and technical papers in their Defence submitted prior to hearing. The Marconi Company would need to deal with each of these in turn in their submissions during the case. In order to do so it was necessary to set out what the 7777 patent actually claimed (see Fig. 14). This was summarised by Astbury as follows:

- a) a transmitter for electric-wave telegraphy consisting of a spark producer having its terminals connected through a condenser with one circuit of a transformer and the other circuit being connected to a conductor and to earth or a capacity, the time period of electrical oscillations in the two circuits being the same or harmonics of each other,
- b) a system of electric-wave telegraphy in which both the transmitter and the receiver contain a transformer, the time period the electric oscillations in the four circuits of the two transformers being the same or harmonics of each other and,
- c) a system of electric-wave telegraphy in which both the transmitter and the receiver contain a transformer one circuit of which is a persistent oscillator and the other a good radiator or absorber of electrical oscillations, all four circuits having the same time period or being harmonics of each other.<sup>44</sup>

In essence the 7777 patent claimed to be the solution to the tuning problem which had plagued wireless-telegraphy development since its beginning by eliminating the radiation of power over a broad band and reducing interference by introducing selectivity between signals.



**Figure 14. Marconi's 7777 Patent of 1900.**  
*Source: The Patent Office*

### Swinburne's Evidence in Chief

The task of explaining the 7777 patent to the Court fell largely to James Swinburne, who had been chosen by the Marconi Company to lead expert evidence. Swinburne was an established engineering consultant who had commenced giving technical evidence in the High Court of Justice on patent matters in 1899. He was a former President of the Institution of Electrical Engineers (1902-1903), a Fellow of the Royal Society and at the time of this case was the President of the Faraday Society.<sup>45</sup> During three days in the witness box Swinburne was to cement the foundations of the Marconi Company's case against the BRT & T Co.

Swinburne's priority was to put the 7777 patent squarely in the context of the historical development of wireless telegraphy up to 1900. His evidence in chief consisted of a detailed commentary on scientific thinking up to

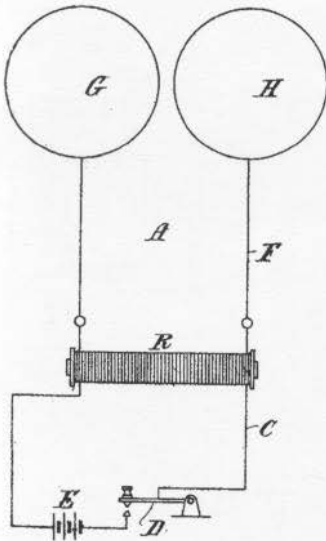


Fig. 1.

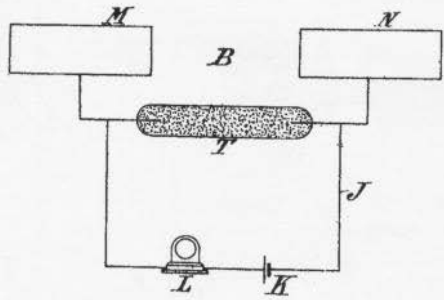


Figure 15A. Marconi's 1896 Patent.  
Source: The Patent Office

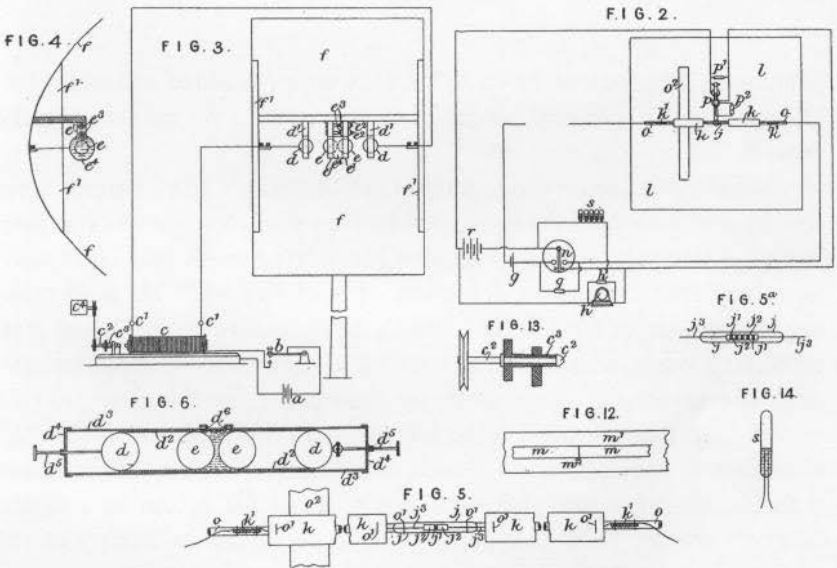


Figure 15B. Marconi's 1896 Patent.  
Source: The Patent Office



- a) Marconi used an open circuit to both create and detect ether waves, the transmitter being a good radiator and the receiver being a good absorber,
- b) a vertical wire connected to the earth through a spark gap replaced Hertz's horizontal radiator and,
- c) an improved Branly coherer was utilised in the receiver connected to a mechanical arrangement for de-cohering the metal filings.<sup>52</sup>

The 1896 patent was therefore not a complete answer to the dilemma raised by Lodge in his earlier lecture. Marconi's transmitter being a good radiator and his receiver a good absorber could not maintain oscillations.

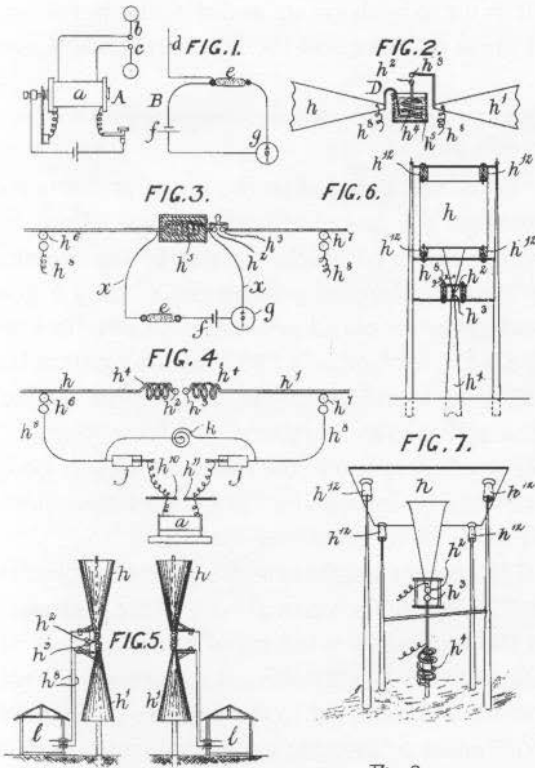
Swinburne recognised that Sir Oliver Lodge's 1897 syntony patent (see Figs. 16A and 16B) had "got a considerable way in syntony or tuning". However Lodge's solution was characterised by Swinburne as a "compromise."<sup>53</sup> In order to increase the persistence of vibration in the radiating circuit Lodge had reduced its radiating qualities and by increasing the accumulative power of the receiving circuit he had reduced its receiving qualities.

In Swinburne's opinion the 7777 patent sought to address the shortcomings of Lodge's compromise. In the 7777 patent the vertical wire of the transmitter "is connected to earth through the secondary winding of a transformer of a kind suitable for the transformation of very rapidly alternating electric currents, and the primary of this transformer is connected to the spheres or terminals of the sparking appliance. A condenser of suitable capacity is introduced in series with the primary."<sup>54</sup> In other words two circuits were created, the closed circuit of the primary being a good conserver and the open circuit of the secondary being a good radiator of waves. Similarly in the receiver the vertical wire was connected to earth through the primary of a transformer, and the secondary was connected to the coherer. Marconi's 7777 patent then stated:

"The four circuits, namely those including the primary and the secondary of the transformer in the transmitter and the primary and the secondary of the transformer in the receiver, should be so adjusted as to make the electric time period the same in each, i.e. the product of self induction multiplied by the capacity is the same in each case. But in lieu of the time periods being the same in each, they may be the harmonics of each other."<sup>55</sup>

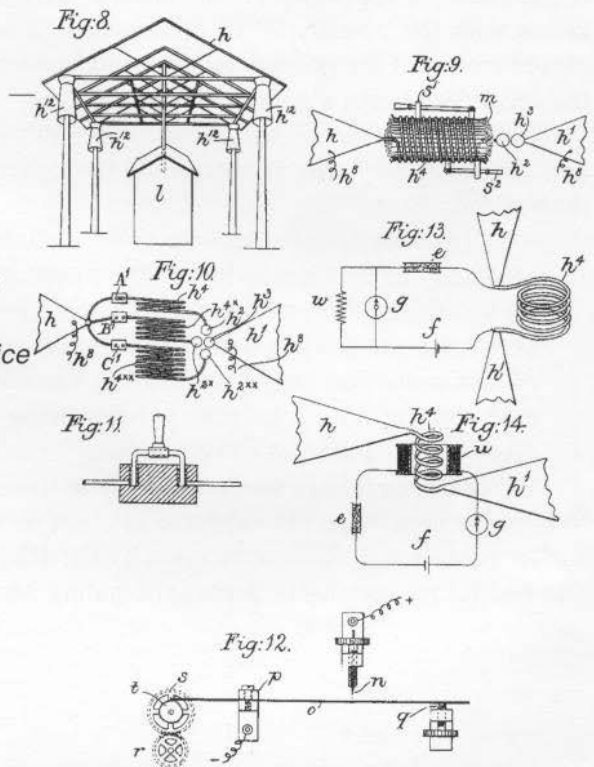
While not expressly stated in the patent, this to Swinburne was tuning. Swinburne concluded his evidence-in-chief by noting that he had read the earlier patents and documents cited by the BRT & T Co. in their Defence and had found nothing in them anticipating Marconi's inventions.<sup>56</sup>





**Figure 16A. Lodge's 1897 Patent**  
 Source: The Patent Office

**Figure 16B. Lodge's 1897 Patent**  
 Source: The Patent Office



## Swinburne's Cross-Examination

The cross-examination of James Swinburne was conducted by the patent lawyer Thomas Terrell KC representing the BRT & T Co. Under cross-examination Swinburne would be asked to review the work of Tesla, Lodge, Thompson, Braun and Marconi in relation to the question of tuning. The Swinburne cross-examination pursued what were to become the two key themes of the BRT & T Co.'s Defence. The first broad objective of Terrell's cross-examination of Swinburne was to attempt to establish tuning prior to the 7777 patent, while a second narrower objective was to distinguish the elements of the Balsillie system by undertaking a detailed examination of the 7777 patent itself.

Swinburne was first taken to Tesla's 1891<sup>57</sup> and 1896<sup>58</sup> patent specifications which the BRT & T Co. contended demonstrated two examples of pre-1900 transformer circuits capable of being tuned together. In the first specification Tesla showed a transformer in which he had proposed to raise the voltage of the oscillations produced by a sudden discharge of a condenser for the purpose of lighting electric lamps. These circuits, although tightly coupled, Swinburne believed, made no suggestion of tuning. In the second patent Tesla had suggested tuning of various circuits, but not in "an intelligible manner."<sup>59</sup> In Swinburne's view "Tesla was a very clever man, but, with all respect, ...[not] a very clear thinker."<sup>60</sup> This was compounded by a close reading of Tesla's 1893 paper<sup>61</sup> in which he had discussed the theory of resonance, but had doubted its utility when applied to transmission without wires. This suggested that Tesla's 1896 patent did not intend to cover an application to wireless telegraphy.

Terrell then returned to Lodge's 1897 patent. Again Swinburne acknowledged that the Lodge patent was a "great advance" because it highlighted the importance of syntony between the transmitter and the receiver.<sup>62</sup> When pressed by Terrell as to the scientific knowledge contained in the Lodge 1897 patent relating to tuning, Swinburne observed that "Marconi's invention might be fairly be described as the introduction of a closed circuit with a large capacity into the invention described in Lodge's first claim."<sup>63</sup>

The BRT & T Co. had cited two inductive telegraphy patents in its Defence. These were Lodge's second 1897 patent<sup>64</sup> and Silvanus Thompson's patent of 1898.<sup>65</sup> In Lodge's patent the primary and secondary circuits had adjustable arrangements for precise tuning so that the primary and secondary closed circuits could operate by accumulation on the principle of resonance in order for selectivity to be secured. Thompson's patent essentially followed the same lines. Under cross-examination Swinburne was dismissive of both patents; in the case of Lodge's patent "an engineer who understood the matter would have left all that stuff out"<sup>66</sup> whilst in Thompson's patent the tuning of some of the circuits was considered "useless."<sup>67</sup>

Central to the BRT & T Co.'s Defence was Braun's patent of 1899 (see Fig. 17).<sup>68</sup> Braun's patent set out to categorise electrical vibrations into three classes:

- a) those with the low frequency of ordinary alternating currents which are produced mechanically,
- b) those with the much higher frequency of oscillations produced by the discharge of Leyden jars, with or without induction coils in the circuit for the purpose of lowering the frequency and increasing the wavelength and
- c) those of the enormous frequency of Hertz.<sup>69</sup>

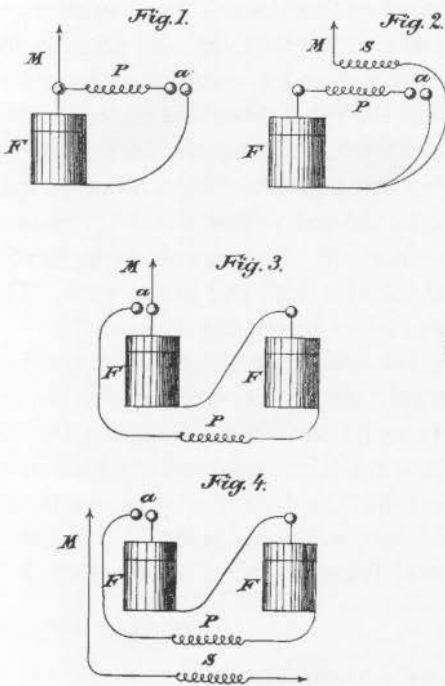
In Swinburne's opinion, what Braun thought he had invented in this patent for the first time was the use of waves of a length between the Hertz wave and the ordinary wave of alternating current. However, "What Braun thought was new was not new"<sup>70</sup> because Marconi was already using, and Lodge proposed to use, electrical oscillations falling into Braun's second class. Whilst Braun used great capacities with low frequencies and had loose coupling, this did not necessarily constitute tuning. Swinburne maintained that Braun did not intend to tune in 1899 and at that time the importance of tuning between the primary and secondary of a wireless telegraph transmitter was not recognised. As a result a "skilled electrical engineer with knowledge of wires (sic) and with Braun's specification before him would not be able to produce the Marconi result."<sup>71</sup>

In the cross-examination of Swinburne on the 7777 patent Terrell concentrated almost entirely on the type of transformer Marconi intended to use in the transmitting and receiving circuits. It was the BRT & T Co.'s contention that Marconi had used a two-coil transformer in the 7777 patent whereas they had used an autotransformer which operated by way of inductive shunt. Swinburne was shown a demonstration of a "shunt" used in the BRT & T Co.'s apparatus and concluded that he did not like the term used in relation to the apparatus as it was not, in his opinion, a pure shunt.<sup>72</sup> Under cross-examination Swinburne did, however, concede that the 7777 patent referred only to a "two-circuit" transformer.<sup>73</sup>

### **Swinburne's Re-examination**

It was clear to Astbury that Swinburne had not dealt well with the two-coil transformer issue raised by the BRT & T Co. Astbury's re-examination of Swinburne was therefore largely confined to an elaboration on the differences between shunts, transformers and autotransformers.

Swinburne explained the operation of an autotransformer and went on to outline to the Court the differences in construction between shunts and transformers. In Swinburne's view there was a great difference between the



**Figure 17.** *Braun's 1899 Patent*  
 Source: *The Patent Office*

operation of a plain shunt and an inductive shunt. Whilst the action of an inductive shunt was the same as that of an autotransformer, Swinburne remained unconvinced that the BRT & T Co.'s apparatus operated purely by inductive action.

Astbury also sought clarification of Swinburne's views in relation to Tesla's second patent, which had been dismissed rather flippantly in the evidence-in-chief. Swinburne made two points. Firstly, Tesla gave no direction for tuning with his open or lamp circuit, and said nothing about a radiator. Secondly, the proportion of energy in the Hertz wave formed in the Tesla transformer was infinitesimal compared with that spent in the brush discharge.<sup>74</sup>

### Marconi's Other Witnesses

The Marconi Company called only two further witnesses who were to reinforce the position outlined in Swinburne's evidence. They were Dugald Clerk, who was an engineering patent law expert, and John St. Vincent Pletts, an electrical engineer employed by the Marconi Company with 11 years experience in the field of wireless telegraphy.

Dugald Clerk was of the view that the tuning of a closed oscillatory circuit to an open radiating circuit had never been even mentioned before

the 7777 patent. In fact Dugald Clerk believed that Braun's work, in pursuing long wavelength oscillations instead of a train of waves, had actually led other investigators away from the right method of tuning. In regard to Lodge's 1897 patent Dugald Clerk submitted that there was no suggestion in the patent of a transmitter consisting of two interacting oscillatory circuits, nor of a receiver with a second circuit that could be tuned. Finally, with respect to the transformer reference contained within the 7777 patent, Dugald Clerk was clear that "There was nothing ...that was not as applicable to an autotransformer as to a two-coil transformer" and in any case, "The name 'transformer' has long been applied to an autotransformer."<sup>75</sup>

John St. Vincent Pletts evidence focused upon the achievements of the Marconi system itself, based largely on his experience in Marconi installations in the Sandwich Islands using the 1896 Marconi patented system, and later in Portuguese Africa, installing equipment based upon the 7777 patent. Pletts estimated that transmitting distances had immediately improved from 70 to 150 miles using the design outlined in the 7777 patent.<sup>76</sup> He, like Swinburne and Dugald Clerk, found nothing in the BRT & T Co.'s Defence.

### **Marconi Company's Summation**

Walter KC precisely summed up the Marconi Company's case on the sixth day of the hearing, essentially following Swinburne's evidence. His approach was measured and assured, reflecting the confidence of the Marconi Company in its case. According to Walter the first great step forward in wireless telegraphy occurred when Marconi earthed his aerial in the 1896 patent. Lodge's first patent of 1897 could not be tuned, and Tesla never contemplated tuning. In Lodge's second 1897 patent he returned to magnetic induction telegraphy and said that Thompson's 1898 patent was "useless." Braun's patent of 1899 did not contain tuning and it was only in his later patent that he realised the advantages of earthing. The essence of Marconi's invention in the 7777 patent was the inductive linking of the aerial and the oscillator, which could only be done by tuning them together. In doing so Marconi obtained combinations of electro-static and electro-magnetic effects, that were later to become known as the 'stroking' effects on the aerial.

It was conceded in summation by the Marconi Company's counsel that the apparatus outlined in the 7777 patent did contain a two-coil transformer. However whilst the BRT & T Co.'s apparatus linked the oscillating and radiating circuits by an autotransformer, this may be looked upon as two coils and the same effects are obtained from it as from two independent coils.<sup>77</sup>

## The BRT & T Co.'s Case

The Marconi Company's evidence had left only two potential avenues for the BRT & T Co. to exploit which had not been convincingly rebutted by Swinburne and the other expert witnesses. The first went to the question of whether the 7777 patent was restricted to a two-coil transformer whilst the second dealt with the question of whether the Lodge and Braun patents anticipated the 7777 patent.

Terrell KC was joined by Arthur Colefax to present the BRT & T Co.'s defence. Colefax was an accomplished patent lawyer who had studied science in Germany and at Oxford prior to becoming a London-based barrister. The BRT & T Co. had assembled a large number of expert witnesses including William Duddell, a Fellow of the Royal Society and a Vice-President of the Institution of Electrical Engineers, and Charles Vernon Boys, Professor of Physics at the Royal College of Science at South Kensington.<sup>78</sup> Perhaps the most interesting witness was Neville Maskelyne, who had worked with Balsillie at Huntstanton and Skegness. Maskelyne had a long history of opposition to the Marconi Company and has been closely linked to the infamous jamming incident in June, 1903 when Professor Fleming's demonstration of Marconi equipment at the Royal Institution in London was disrupted by signals from a nearby source.<sup>79</sup>

### The Transformer

Terrell framed the transformer question as "the essence of the claim."<sup>80</sup> This was understandable, given that many working in the field of wireless telegraphy at that time, including de Forest and Shoemaker in the United States, believed that the 7777 patent could be bypassed by using autotransformers in the transmitting and receiving circuits instead of coupled separate coils.<sup>81</sup>

The BRT & T Co. relied on a line of argument based upon the state of knowledge at the time of publication of the 7777 patent in 1900, rather than knowledge available at the time of the hearing of the case in 1910. Following this reasoning Terrell submitted that if the BRT & T Co. had not taken the specific transformer referred to in the 7777 patent they had not infringed. Alternatively, if Marconi had only described a two-coil transformer, the use of an autotransformer would be excluded from the patent as it was a well-known instrument in 1900.

The expert witnesses for the BRT & T Co. agreed that in 1900 a transformer was restricted to a two-coil instrument whilst a single coil instrument with an iron core was generally known as an autotransformer. Boys went further by stating that the language of the 7777 patent pointed to a two-coil transformer because the words "secondary winding" were inconsistent with the use of an autotransformer. Duddell agreed, citing the tight coupling of some

transformers in the patent as evidence of the intention to use a two-coil transformer. Swinburne was recalled and dissented on this point, stating that the 7777 patent clearly showed that the transformer must be arranged so that the circuits were loosely coupled.<sup>82</sup>

### **The Braun and Lodge Patents**

Terrell then returned to Braun's 1899 patent and Swinburne's evidence on Lodge's first patent of 1897. In effect Terrell was proposing a simple formula which went along the lines of Lodge plus Braun plus common knowledge equalled Marconi. In order to support Terrell's proposition the BRT & T Co.'s expert witnesses were asked to analyse the same line of patents dealt with by Swinburne in his evidence.

Duddell examined a number of earlier patents in relation to tuning. He conceded that in Lodge's 1897 patent the secondary circuit could not be tuned without the addition of a condenser whilst Thompson's 1898 patent contained complete instructions on tuning.<sup>83</sup> Overall however it was Duddell's view that Braun's 1899 patent came closest to tuning. Duddell believed that no distinction could be made between the Braun and Marconi patents, and except for the identification of tuning there was no difference between Braun's Fig. 4 and Marconi's transmitter. When asked by Terrell how he would adapt Braun's Fig. 4 in 1900, Duddell replied that he would substitute the transformer for a Tesla transformer and then take turns off the primary until the greatest effect on the secondary was produced.<sup>84</sup>

Neville Maskelyne drew the same conclusion as Duddell in relation to tuning between the primary and the secondary, but explained the significance of Braun's patent in quite different terms. To his mind the problem for inventors since Hertz's time was trying to create a store of energy that could be given to an open aerial, which was sufficient to generate a train of waves for effective tuning. Braun's Fig. 4 contained a closed oscillating circuit which created that elusive store of energy.<sup>85</sup>

### **BRT & T Co.'s Summation**

In his closing remarks Colefax largely confined himself to the work of Braun and Marconi, the two men who had shared the Nobel Prize in 1909.<sup>86</sup> This approach was not surprising, given that the BRT & T Co. had sought to demonstrate during their case that Marconi had not been solely responsible for the development of wireless telegraphy. Pitting Braun directly against Marconi was certainly a risk, but the tone of the BRT & T Co.'s closing submissions now generally became more desperate, more vitriolic and perhaps more personal as this surviving extract from Colefax's speech indicates:

“Without wishing in any way to belittle Mr Marconi’s achievements, it could not be denied that there was some danger of giving that gentleman too much credit for what had been done. All the marvellous performances of wireless telegraphy were not due to him or his patents. It had been sought to read into Marconi’s patents more than the patentee had said or probably even conceived. ...The document of Braun, undoubtedly a distinguished man of science, has been subjected to ridicule, but when that document had been dissected and unravelled by the expert witnesses there was little that survived of the suggested nonsense of Braun’s document.”<sup>87</sup>

In his summation Colefax maintained that there was a “great danger” in confusing the knowledge of the time of the case with that available at the time of the publication of the 7777 patent. The balance of evidence suggested that the meaning Marconi attached to the word “transformer” in the 7777 patent was that of a two-coil instrument. In other words Marconi took a two-coil transformer and tuned to the two circuits. Braun did not direct the reader of his patent to tune, but if Braun’s patent specification had been taken in 1900 with the intention of translating Fig. 4 with the knowledge of the time, something within the 7777 patent would have been obtained. If Marconi had obtained a new result it was only a matter of degree; Marconi had very short waves whilst Lodge had a longer train. Further, Boys’ evidence indicated that it was not known in 1900 that when two circuits were directly coupled they could be tuned together. Hence it could not be argued that the BRT & T Co.’s autotransformer was a known equivalent of the device in the 7777 patent.<sup>88</sup>

The parties proceeded to make their concluding remarks, and after fourteen days of hearing, the submissions on behalf of the Marconi Company and the BRT & T Co. before the High Court of Justice were finally over. Interestingly, neither Balsillie nor Marconi had been called to give evidence in the case.

### **The Decision**

Mr. Justice Parker handed down his decision on 20 February 1911. The judgment demonstrated a keen understanding of both the principles and problems associated with the practical application of wireless telegraphy in the years leading up to the 7777 patent in 1900. The judgment itself addressed three key issues that had been raised during the course of proceedings. These issues were the proper construction of the 7777 patent, its relationship to the Braun, Lodge and Tesla patents, and an examination of the Balsillie System in relation to the question of infringement.



## The Proper Construction of the 7777 Patent

Mr. Justice Parker was no doubt influenced by the evidence given by James Swinburne, and much of the judgment refers to the expert testimony proffered by Swinburne during the proceedings. Therefore, like Swinburne, Parker commences by reviewing the historical antecedents to wireless telegraphy by examining the principles laid down in the work of Henry, Kelvin, Helmholtz, Clerk Maxwell and Hertz. However, unlike Swinburne, Parker is more interested in focussing on the seesawing battle that developed between Marconi and Lodge in the years 1894 to 1900 in their quest to find the solution to tuning. To Parker the 7777 patent could only be properly interpreted in that context.

Mr. Justice Parker's real starting point was Lodge's 1894 lecture to the Royal Institution on the work of Hertz. The importance of that lecture, according to Parker, was that for the first time the difficulties associated with the full utilisation of the principles of sympathetic resonance were explained and these were the same difficulties which Marconi was to later claim to overcome in the 7777 patent. The point that Lodge was making in 1894, that simultaneous radiation of energy and vibration were incompatible, "was as true now as when Lodge said it, if they remembered that he was referring to a single circuit."<sup>89</sup>

Marconi's 1896 patent then became the first breakthrough. The judgment does not dispute the essential claims of the patent nor its achievements in wireless telegraphy. In Parker's opinion "without the aid of any subsequent improvements the plaintiffs succeeded in sending messages many miles, and thus fully demonstrated the possibility and utility of a system of wireless telegraphy based on the creation and detection of aether waves."<sup>90</sup>

However, the 1896 patent had several drawbacks, and before Marconi's next patent specification of May, 1897<sup>91</sup> Lodge applied for his own patent. In that patent Lodge returned to the problem of sympathetic resonance and recognised that he could secure selectivity if he could get a long series of waves and diminish the amplitude of the first few of them. He therefore compromised by increasing the persistence of vibration of his radiating circuit at the expense of its radiating qualities, and increasing the accumulative power of the receiving circuit at the expense of its absorbing qualities. Mr. Justice Parker concluded that Lodge appreciated the drawbacks of Marconi's 1896 patent, and to some extent met them.<sup>92</sup>

Later in 1897 Lodge applied for another patent in relation to inductive telegraphy, the only importance of which was that the primary and secondary circuits were adjustable for precise tuning, so that when they were tuned to the same frequency they would accumulate on the principle of resonance to secure selectivity.

In 1898 Marconi re-entered the contest with a further patent<sup>93</sup> which included an improved receiver in which the aerial was connected to earth

through the primary of a transformer and the secondary of which contained a coherer. The object of this arrangement was to step up the voltage to ensure the coherer would be more readily affected. The patent went into great detail on the construction of air core transformers, all of which were similar to those used by Tesla to step up the voltage of alternating currents to high frequency. Marconi subsequently obtained two further patents in 1899<sup>94</sup> relating to this form of receiver.

Mr Justice Parker then turned to the 7777 patent itself. Parker completely discounted the relevance of Braun's 1899 patent in relation to the interpretation of the 7777 patent, citing evidence that it was not put into practice or generally known before Marconi's patent of 1900. Marconi's specification commenced by stating that the object of the invention was to not only increase the efficiency of the apparatus, but to also secure selectivity. In Parker's opinion this opening statement in the 7777 patent suggested the general problems of wireless telegraphy, and in particular Lodge's 1897 patent; namely the difficulties of obtaining a train of waves necessary for selectivity, and of increasing the available store of energy in the transmitter.

The effect of the transmitter arrangement proposed in the 7777 patent was reasonably clear to Parker; Marconi had two circuits, the circuit of the primary containing a condenser with the usual provision for discharge through the spark gap, and the circuit of the secondary containing the vertical wire. In doing so Marconi had proposed to meet the difficulties explained by Lodge without the sacrifice Lodge's 1897 patent. Parker paraphrased the outcome:

"Lodge said in truth: "You cannot have your circuit doing two incompatible things, however desirable, at the same time." Marconi says in effect: "Take two circuits and let one do one of the things, and the other do the other." <sup>95</sup>

While Marconi did not expressly state the objects of tuning between the circuits of the transmitter and the circuits in the receiver, Parker was of the view that to anyone acquainted with the progress of wireless telegraphy this would have been "sufficiently clear". Nor did Marconi state why the two circuits of the receiver were to be tuned together. However this was "sufficiently indicated" by what had been said in the 7777 patent regarding the circuits in the transmitter. In other words, in order to understand the claims of the 7777 patent in relation to the receiver, Marconi's patents of 1898 and 1899 need to be taken into account. These patents had already described a receiver in which the vertical wire was connected to earth through the primary of a transformer and the secondary is connected with the condenser. In turn these patents had been incorporated by being cited in the text of the 7777 patent.

Mr. Justice Parker summarised the question of interpretation of the 7777 patent by stating what he saw as the essential features of the invention at some length:

“In order to get over the well-known difficulty in applying the principle of resonance as between receiver and transmitter in a system of wireless telegraphy, the inventor proposed to substitute for a single circuit in both transmitter and receiver a pair of circuits, one of which was so constructed as to radiate or absorb readily, and the other of which was so constructed as to oscillate persistently and be a good conserver of energy. The two circuits of the transmitter were attuned together and linked by means of a transformer in such a way that electrical oscillations in the closed and persistently oscillating circuit build up, and, inasmuch as the primary could act as a receiver of energy for the secondary, maintained similar oscillations in the open and readily vibrating secondary. Similarly the two circuits of the receiver, attuned to the same time period as the circuits of the transmitter, were linked through a transformer in such a way that electrical oscillations in the readily absorbing primary build up similar oscillations in a closed and conserving secondary; only such oscillations had strength to break down the coherer.”<sup>96</sup>

Mr. Justice Parker concluded his remarks on interpretation by noting that “It is not disputed that, if this be the invention, it does get over, to a very great extent if not entirely, the difficulty it was designed to meet” and as a matter of utility “it at once doubled the distance to which effective messages could be sent by means of [a]ether waves.”<sup>97</sup>

### **The Braun, Lodge and Tesla Patents**

Braun’s 1899 patent, according to Parker, “involves many difficulties.”<sup>98</sup> Parker believed that it was reasonably clear on the evidence that Braun was not fully aware of Marconi’s work. In examining the letterpress of Braun’s specification the Court found that it did not convey the remotest suggestion of the problem which the 7777 patent was intended to solve, let alone any bearing on its solution. If the 7777 patent had been anticipated in Braun’s specification this should have been disclosed in Braun’s drawings. In examining those drawings and in particular Fig. 2 and 4 of the specification, Parker concluded that although a competent engineer with a knowledge of the 7777 patent could easily adapt Braun’s specification, a competent engineer in 1899 would probably put Braun’s specification to one side on the basis that “He would have said that Marconi was already doing what Braun claimed, and it was useless pursuing the matter further.”<sup>99</sup>

In determining the question of want of subject matter, Mr. Justice Parker examined Lodge’s 1897 syntony patent in great detail, noting that the mere introduction of two circuits by Marconi in the 7777 patent “was no novelty.”<sup>100</sup>

Fig. 14 of Lodge's 1897 patent had showed an open circuit of the receiving aerial linked through the transformer with the closed circuit containing the coherer. Lodge's idea was to leave his receiving aerial free to vibrate electrically. The secondary circuit could not be tuned to the circuit of the aerial. To Parker, here was Lodge, "an electrical engineer of first-rate ability," making a compromise by partially sacrificing the radiating or absorbing qualities of the aerial. This was critical to Parker's analysis of Lodge's 1897 patent, as he goes on to elaborate:

"[Lodge] introduced two circuits at the receiving end and yet he did not see that if only he utilised the principle of resonance as between those two circuits the problem would have been solved, at any rate at the receiving end, and really the problem at the transmitting end was the same problem from the reverse point of view."<sup>1</sup>

Mr. Justice Parker then paused to pose the question; "How, then, could he treat as obvious at the latter date [of 1900] what so able a man as Lodge entirely failed to see at the former date?"<sup>2</sup> In Parker's opinion Lodge was far from grasping the advantages of two circuits in his 1897 patent. But so, too, was Marconi in his 1898 specification; "He did not, any more than Lodge, tune the two circuits together as he might be expected to do if tuning them were really so obvious a matter."<sup>3</sup> Parker also considered the inductive telegraphy patents of Lodge and Thompson and concluded that tuning in these cases bore no analogy to the tuning of a pair of circuits in the 7777 patent.

After referring to Tesla's 1891 and 1896 patents, and his lecture of 1893, Parker took the view that in 1896 Tesla himself would have doubted the application of tuning within the scope of the patents. While there was some evidence to suggest that manufacturers of Tesla transformers adjusted the primary to the secondary, and this had also occurred in laboratories, James Swinburne, who the Court accepted was very experienced in these matters, had never heard of such a practice. On this basis Parker said that it could hardly have been common knowledge that the circuit of the primary and secondary of a transformer should be tuned together.

### **The Balsillie System and the Question of Infringement**

Mr. Justice Parker said that the Balsillie System, as described to the Court, contained all the essential features of the invention protected by the 7777 patent. However, this in itself did not determine the question of infringement, as the BRT & T Co. in its Defence had contended that the word "transformer" in the 7777 patent was limited to a transformer with two separate coils, and that their use of an autotransformer in the Balsillie System did not therefore constitute an infringement.

In addressing the BRT & T Co.'s position Parker examined the history and use of transformers generally. Parker outlined that originally transformers were instruments used to step up or step down voltages of electric currents using two separate and distinct coils. Over time "transformer" came to refer to instruments which transformed electrical energy in one circuit to magnetic energy in the field and then back to electrical energy in another circuit. Eventually it was discovered that the same effect could be achieved using a single coil, which became known as an "autotransformer."

While Parker accepted that there were distinct differences between transformers and autotransformers, he concluded that an electrical engineer in 1899 would not have had any doubt that what could be done by an air-core two-coil transformer could also be done by an air-core autotransformer. The use of the two-coil transformer in the 7777 patent was therefore not an essential feature. This conclusion gave rise to the legal principle for which the case is perhaps remembered today in patent law:

"The merit of the invention lies in the idea, rather than in the particular means by which he carries it. ...It is, however, a matter of indifference so far as the science of this invention was concerned, whether a transformer or an autotransformer be used."<sup>4</sup>

Mr. Justice Parker held that the BRT & T Co., who had taken all the essential parts of the 7777 patent, were the infringers, notwithstanding that they had substituted an autotransformer for a transformer, and notwithstanding that the use of an autotransformer with an air-core might be new.<sup>5</sup>

The Marconi Company therefore succeeded in their action against the BRT & T Co. The Court indicated that if an appeal was made within fourteen days of the decision an injunction against the use of existing Balsillie System equipment would be suspended during the appeal. However no fresh sales should occur. For the Marconi Company the decision was a magnificent victory, but for the BRT & T Co. it represented complete and utter defeat.

### **The Implications**

The decision of Mr Justice Parker in *Marconi v. British Radio Telegraph and Telephone Company* changed the landscape of wireless telegraphy forever. The impact of the decision spread quickly, in the first instance leading to the winding up of the BRT & T Co. However the legacy of the case was to prove more far reaching and enduring because it was to have almost immediate commercial effects on the Marconi Company's competitors throughout the world and became the definitive interpretation of the history of early wireless telegraphy for at least the next 30 years.

## The BRT & T Co.

The BRT & T Co. needed to evaluate their position immediately after Mr. Justice Parker's devastating decision. Balsillie himself picks up the story :

"In February of 1911 the decision in the action *Marconi v. British Radio* was given against my Company, and all companies, other than the Marconi Company and Telefunken Co., met at the British Radio Offices to consider whether a combination could be formed to purchase the Lodge syntonic patent on the understanding that (1) Lodge would make application for the extension of his patent for a period of seven years; and (2) was successful in obtaining this extension.

Agreement between the British Radio and other companies was impossible so the British Radio Company decided not to appeal against the decision and to use such monies as could be raised to purchase the Lodge patent outright after the extension application had been granted."<sup>6</sup>

Balsillie's fellow directors were not so confident. On 27 March 1911 an Extraordinary General Meeting of the BRT & T Co. was held, at which it was unanimously passed that the company be wound up voluntarily and that George Pascoe Grenfell be appointed liquidator.<sup>7</sup> Grenfell busied himself with the task and by 6 June the BRT & T Co was liquidated and the final meeting of directors had taken place less than two years since it was first registered as a company.<sup>8</sup>

## The United Kingdom

The Marconi Company in the United Kingdom read the decision of Mr. Justice Parker as "proving conclusively the indisputable claim of the Marconi system of wireless telegraphy to be based on a master patent."<sup>9</sup> Such a broad interpretation of the 7777 patent would place other wireless telegraphy companies in an invidious position because they would be bound by both the Parker judgment on the one hand and the restrictions imposed by the Postmaster-General's Department on the other. In effect "the first demands that the broadly interpreted Marconi patent be not infringed, whilst the latter practically insists on a method of syntonic transmission embracing modern practice in syntonisation of the circuits being used."<sup>10</sup>

An opportunity to test this position arose later in 1911 when the Lodge syntony patent was reviewed by the High Court of Justice. Mr. Justice Parker's decision in *Marconi v British Radio Telegraph and Telephone Company* was clearly sympathetic to Lodge's 1897 syntony patent in that it recognised the contribution that patent had made to the development of wireless telegraphy. But the Lodge patent had never been a commercial success under the stewardship

of the Lodge-Muirhead Wireless and General Telegraphy Syndicate, Ltd. that had controlled the patent since 1901.

The Lodge patent was due for extension and came before Mr. Justice Parker in April, 1911 for consideration in the case *In the Matter of Lodge's Patent*,<sup>11</sup> in which the Lodge-Muirhead Syndicate sought a fourteen-year extension of Lodge's 1897 patent. The Lodge-Muirhead Syndicate retained Walter KC and James Hunter Gray, two members of the successful Marconi legal team, to argue their case. The British Attorney General opposed the application on a number of grounds. The evidence given in the case was almost a rerun of *Marconi v. British Radio Telegraph and Telephone Co.* with the exception that the status of the 7777 patent was not directly canvassed. The case resulted in Parker taking the unusual step of granting the Lodge-Muirhead Syndicate a seven-year extension to Lodge's 1897 patent on 28 April 1911. Mr. Justice Parker took the view that "It is, in my opinion, beyond dispute that the system of wireless telegraphy disclosed by the Patent in question was one of great merit, and, so far as concerns the utilisation of the principle of resonance and the consequent possibility of securing that selectivity which is indispensable for practical purposes, constituted a great advance on Marconi's 1896 Patent."<sup>12</sup>

While the decision in *In the Matter of Lodge's Patent* did not directly rule that the 7777 patent infringed on Lodge's syntony patent, it nevertheless proved to be a headache for Godfrey Isaacs, who by July, 1911 had lodged writs against the Lodge-Muirhead Syndicate.<sup>13</sup> However, litigation was avoided when a settlement was reached in October, 1911 whereby the Marconi Company paid £55,000 for the Lodge patents and appointed Sir Oliver Lodge as a scientific advisor to the Company.<sup>14</sup> At an Extraordinary General Meeting of the Marconi Company later that same month Godfrey Isaacs noted :

"By this arrangement we have broken the back of the litigation through which it was necessary for us to pass; there remains little more to be done in this direction in this country."<sup>15</sup>

With the capture of the Lodge patents the Marconi Company were thus placed in an almost unassailable position in the United Kingdom. However, *In the Matter of Lodge's Patent*, it was suggested that the 7777 patent could not stand alone, and without the Lodge syntony patent the Marconi Company remained exposed both commercially and at law.

### The United States

American Marconi heralded Mr. Justice Parker's decision in *Marconi v. British Radio Telegraph and Telephone Company* as a far reaching one which would potentially give the Company "complete control of the wireless situation."<sup>16</sup> John Bottomley, Vice President of the Marconi Wireless Telegraph

Company of America, spoke of the decision in the New York Times the day after it was handed down and foreshadowed its impact in that country and elsewhere:

“It is the intention of the Marconi Company to press the matter to a final issue in the United States and all parts of the world where an infringement is alleged either by manufacturers or users. According to Mr. Bottomley, if it is successful, its rivals must either discover a device at present undreamed of, or pay such royalties as the Marconi Company decides to require, or go out of business altogether.”<sup>17</sup>

American Marconi moved quickly, filing suit against its major competitor, the United Wireless Telegraph Company, in May, 1911 on the grounds of infringement of the U.S. equivalent of the 7777 patent, known as patent 763,772 in that country.<sup>18</sup> This move was intended to strike United at a particularly difficult time, as the company had endured a messy mail fraud trial in 1910 and was in receivership by early 1911.<sup>19</sup> Initially the Marconi Company attempted to negotiate with receivers to gain control of United but after the breakdown of those negotiations in February, 1912 Bottomley announced that no less than Marconi himself would come to the United States to give evidence in the case.<sup>20</sup> On 15 March 1912 Marconi arrived in New York aboard the *Lusitania* accompanied by Godfrey Isaacs. With the Marconi Company ready to press on with its infringement case and Marconi’s arrival to give evidence, United’s stockholders experienced a change of heart, seeking agreement to a consolidation of United with the Marconi Company.<sup>21</sup>

However, this sentiment did not sway Marconi and Isaacs, who were determined to pursue the patent infringement case. Saul S. Myers, representing United stockholders, accused the Marconi Company of attempting to depress the value of United’s remaining assets by pursuing the infringement suit.<sup>22</sup> Isaacs was unrepentant, bringing the matter to trial in the United States District Court on March 25.<sup>23</sup> On the day the trial commenced it was announced that the two companies had reached agreement and that, as a consequence, United would make no Defence and would consent to a decree in favour of American Marconi without the matter going to trial.<sup>24</sup> By April, 1912 the 400 ship and 50 land stations controlled by United had passed into the hands of the Marconi Wireless Telegraph Company of America for \$US700,000. Almost overnight American Marconi had grown to control 500 ship and 70 land stations as well as engineering and manufacturing facilities in the United States.<sup>25</sup> The stage was set for the American Marconi to establish a near monopoly position in the United States.

In the United States Bottomley and American Marconi had propounded a view that the decision in *Marconi v. British Radio Telegraph and Telephone Company* created a near monopoly patent situation in the field of wireless telegraphy. In truth the settlement with United Wireless meant that the



United States equivalent of the 7777 patent was not tested before the courts at that time, and the English decision in *In the Matter of Lodge's Patent* had already suggested that the 7777 patent did not 'cover the field' in the United Kingdom.

### The Spread of Litigation and the Legacy of the Case

The tide of Marconi patent litigation rolled on in the following two years to include Siemens in the United Kingdom who controlled the Telefunken patents,<sup>26</sup> the National Electrical Signaling Company in the United States over the Fessenden patents,<sup>27</sup> France<sup>28</sup> and the Australian<sup>29</sup> and New Zealand governments.<sup>30</sup>

The decision by Mr. Justice Parker in *Marconi v. British Radio Telegraph and Telephone Company* was presented by the Marconi Company as a determination which allowed the 7777 patent to 'cover the field' and create a near monopoly in wireless telegraphy under patent law. However, in reality, this position was circumscribed by the recognition given by Parker in *In the Matter of Lodge's Patent* to Lodge's syntony patent in the United Kingdom, and the fact that the patent question was never conclusively tested by United Wireless in the United States. Nevertheless, *Marconi v. British Radio Telegraph and Telephone Company* proved to be a watershed in the history of wireless telegraphy because it gave the Marconi Company the leverage it required to dispose of both large and small competitors and to consolidate commercial domination of growing market opportunities. But, more importantly, the case largely wrote the 'official' history of early wireless telegraphy. In effect Mr. Justice Parker's decision became the conventional view of the early history of wireless telegraphy until the United States Supreme Court decision, over thirty years later, in *Marconi Wireless Telegraph Company of America v. United States*, in which it was held that John Stone Stone's patents anticipated the Marconi 763,772 patent in that country.<sup>31</sup>

And what of the young Australian engineer John Graeme Balsillie? In May, 1911 Balsillie applied for and was appointed to the position of Engineer of Radiotelegraphy for the Australian government and sailed from the United Kingdom in August of that year.<sup>32</sup> The primary responsibility of the position would be to establish a network of coastal wireless telegraphy stations around Australia. The long journey home gave Balsillie the opportunity to review the wireless telegraphy position in Australia very closely. As he studied the patents he realised that Lodge's syntony patent, the Telefunken systems patents, the Poulsen patents and elements of the Marconi patents were not in force in Australia and could therefore be considered public

property. Perhaps, thought Balsillie, the problems he encountered in the United Kingdom could be overcome in Australia.<sup>33</sup> Meanwhile, the Marconi Company's representative had written to the Australian government in July, 1911 on the issue of the protection of patent rights.<sup>34</sup> So the battle lines were being drawn once again, this time on the other side of the world.

Ah, but that's another story!

### Sources and Footnotes

1. See e.g. Hugh G.J. Aitken *Syntony and Spark: The Origins of Radio* New York 1976; 2d ed. Princeton, New Jersey 1985; Leland Anderson *Priority in the Invention of Radio Tesla vs. Marconi* Antique Wireless Association Monograph (New Series) No. 4 No date; Sungook Hong *Marconi and the Maxwellians: The Origins of Wireless Telegraphy Revisited* Technology and Culture Volume 35 1994 at pp.717-749; Peter Rowlands and J. Patrick Wilson (eds) *Oliver Lodge and the Invention of Radio* PD Publications 1994; Peter Rowlands *Oliver Lodge's Wireless Experiments at Oxford in 1894* Bulletin of the British Vintage Wireless Society Volume 21(2) 1996 at pp.36-37; Berthold G. Bosch *The Priority on Wireless Telegraphy: Oliver Lodge in 1894 or Guglielmo Marconi in 1895?* Bulletin of the British Vintage Wireless Society Volume 22(1) 1997 at pp.43-44.
2. *Marconi v. British Radio Telegraph and Telephone Company, Ltd* 28 Reports of Patent, Design, and Trade Mark Cases (hereafter R.P.C.) 181.
3. Australian Archives (ACT): A2911; 9/1909 PT1, Wireless Telegraphy, Charles Bright, Report on Balsillie System of Wireless Telegraphy, 15 December 1909 at pp.1-3.; *The Electrical Engineer* 20 August 1909 at p.237.
4. British Patent No. 15,022 of 1905. A British patent application without a complete specification was made by Balsillie on 7 November 1904 (British Patent No. 24,093 of 1904) and a later application (British Patent No.11,057 of 26 May 1905) was subsequently abandoned.
5. *The Electrician* 63 4 June 1909 at p.289; Australian Archives (ACT): A2911/1; 1411/1911, Wireless Telegraphy-Appointment of J.G. Balsillie as Wireless Expert, Letter of Application by J.G.Balsillie to High Commissioner's Office for position of Commonwealth Director of Wireless Telegraphy, 16 May 1911 at pp.1-3.
6. *The Electrician* 58 23 November 1906 at p.197.
7. *The Electrician* 62 5 February 1909 at p.669.

8. *The Electrician* 62 4 December 1908 at p.76. On Balsillie's experience outside Britain see Australian Archives (ACT): A432/86; 29/2756 PT2, Patent Applications 6523/12 and 6524/12. Mr Balsillie Part 2, Statutory Declaration by J.G. Balsillie 12 December 1913 *In The Matter of an Application for Letters Patent* No.6524 of 1912 at pp.14-15; *The Times*(London Engineering Supplement) 10 February 1909 at p.18; *The Scientific Australian* December 1913 at p.13; *Punch* (Melbourne) 13 July 1916 at p.44.
9. See Australian Archives (ACT): A432/86; 29/2756 PT6, Papers ie. Shaw and Balsillie Patents and Dispute Part , Statement by J.G. Balsillie: Main Statement A, 19 March 1915 at p.1; Australian Archives (ACT): A2911/1; 1411/1911, Wireless Telegraphy-Appointment of J.G. Balsillie as Wireless Expert, Letter of Application by J.G. Balsillie at p.3.; Public Records Office BT31 12850/10424, *Register of Directors or Managers of the British Radio Telegraph and Telephone Company,Ltd* 5 November 1909 at p.2.; *Electrical Trades Directory* ("The Blue Book") 1911 at p.726.
10. *The Times* (London) 27 October 1909 at p.17.
11. *The Electrician* 64 5 November 1909 at pp.157-158.
12. 28 R.P.C. 181 at 188.
13. Australian Archives (ACT): A2911; 9/1909 PT1 , *Wireless Telegraphy*, Charles Bright, Report on Balsillie System, n.1 at p.10.
14. In Australian Archives (ACT): A432/86; 29/2756 PT2, Patent Applications 6523/12 and 6524/12. Mr Balsillie Part 2, Statutory Declaration by J.G. Balsillie, Mr Balsillie indicates that the BRT & T Co. freely used the Balsillie System in Spain (at p.15) whilst in *Lehrbuch der Drahtlosen Telegraphie*, Stuttgart 1916, Dr J. Zenneck notes that the Balsillie System was purportedly used by Societe Francaise Radio-Electrique (n.190 at p.498).
15. *Commonwealth Government Gazette* No. 55; D.J. Amos *The Story of the Commonwealth Wireless Service* Adelaide 1936 at pp. 1-2.
16. Australian Archives (ACT): A2911/1; 9/1909 PT1,*Wireless Telegraphy*, Charles Bright, Report on Balsillie System at pp.13-14.
17. *The Electrician* 64 7 January 1910 at pp.513-514.
18. 28 R.P.C. 181 at 188.
19. *The Times* (London) 23 September 1910 at p.16f.
20. *The Electrician* 64 18 February 1910 at p.775.
21. Australian Archives (ACT): A2911; 9/1909 PT1 , *Wireless Telegraphy*, Charles Bright, Report on Balsillie System at p.2.
22. Successively outlined in British Patents Nos. 15,022 of 1905, 8,972 of 1908, 22,930 of 1909, 24,388 of 1909 and 27,395 of 1909.
23. Fig. 1 is taken from British Patent No.8,972 of 1908.
24. Fig. 2 is taken from British Patent No.27,395 of 1909. Fig. 3 and 4 are taken from Australian Archives (ACT): A2911; 9/1909 PT1,*Wireless Telegraphy*, Letter from G.P. Grenfell of the BRT & T Co. to Australian

- High Commission in London, Attachment: The Balsillie System of Wireless Telegraphy, 1 November 1909.
25. *The Electrician* 64 7 January 1910 at p.513.
26. Australian Archives (ACT): A2911; 9/1909 PT1, *Wireless Telegraphy*, Charles Bright, Report on Balsillie System at pp.5-6.
27. *Ibid.* at p.6.
28. *Ibid.* at p.5.
29. Fig. 5 is taken from British Patent No.22,930 of 1909. The photograph in Fig. 6 is taken from Australian Archives (ACT): A2911; 9/1909 PT1, *Wireless Telegraphy*, Letter from G.P. Grenfell of the BRT & T Co. to Australian High Commission in London, Attachment: The Balsillie System of Wireless Telegraphy, 1 November 1909.
30. Australian Archives (ACT): A2911; 9/1909 PT1, *Wireless Telegraphy*, Charles Bright, Report on Balsillie System at pp.5-6.
31. Australian Archives (ACT): A2911; 9/1909 PT1, *Wireless Telegraphy*, *The "Balsillie" System of Radio Telegraphy and Telephony*, The British Radio Telegraph and Telephone Co. Ltd at p.3.
32. Fig. 7 is taken from British Patent No. 15,022 of 1905.
33. Fig. 8 is taken from British Patent No. 24,388 of 1909. The photograph of the receiver in Fig. 9 is taken from Australian Archives (ACT): A2911; 9/1909 PT1, *Wireless Telegraphy*, Letter from G.P. Grenfell of the BRT & T Co. to Australian High Commission in London, Attachment: The Balsillie System of Wireless Telegraphy, 1 November 1909.
34. Australian Archives (ACT): A2911; 9/1909 PT1, *Wireless Telegraphy*, Charles Bright, Report on Balsillie System at p.10.
35. Fig. 10-13 are based upon schematics contained in Australian Archives (ACT): A2911; 9/1909 PT1, *Wireless Telegraphy*, Charles Bright, Report on Balsillie System at pp.11-13; *The Electrician* 64 18 February 1910 at pp. 775-776.
36. In fact W.J. Baker *A History of the Marconi Company* Methuen & Co Ltd 1970 cites hesitancy over patent infringements as a contributing factor in the resignation of previous Marconi General Manager Cuthbert Hall in 1908 (at p.130). See also Susan J. Douglas *Inventing American Broadcasting 1899-1922* John Hopkins University Press 1989 at pp.181-184.
37. British Patent Nos. 10,245 of 1902 and 4,593 of 1907.
38. 28 R.P.C.181 at 188.
39. Public Records Office BT31 12850/12404, Agreement, 9 December 1910.
40. *The Times* (London) 13 December 1910 at p.3. On Astbury's career see *Dictionary of National Biography* 1931-1940 at pp.22-23; on Walter see *The Law Journal* 19 April 1919 at pp.150-151; on Gray see *The Law Journal* 6 June 1925 at p.542 and 13 June 1925 at p.545.

41. 28 R.P.C. 181 at 192, 194. Transcript of the case was not found after a search of the Public Records Office at Kew and checking with the Marconi Archivist at Chelmsford. As a result the outline of submissions are based on the case report (28 R.P.C. 181) and contemporary daily summaries that appeared in *The Times* (London).
42. *The Times* (London) 13 December 1910 at p. 3.
43. 28 R.P.C. 181 at 192.
44. *Ibid.* at 188.
45. On Swinburne's career see *Journal of the Institution of Electrical Engineers* May 1958 at p. 269.
46. British Patent No. 12,039 of 1896.
47. British Patent No. 11,575 of 1897.
48. 28 R.P.C. 181 at 193.
49. *Ibid.*
50. Oliver Lodge *The Work of Hertz, The Electrician* 8 June 1894 at pp.154-155 cited 28 R.P.C. 181 at 203.
51. *The Times* (London) 14 December 1910 at p.3.
52. 28 R.P.C. 181 at 203.
53. *The Times* (London) 15 December 1910 at p.3.
54. British Patent No.7777 of 1900.
55. *Ibid.*
56. *The Times* (London) 15 December 1910 at p.3.
57. British Patent No. 8,575 of 1891
58. British Patent No. 20,981 of 1896.
59. 28 R.P.C. 181 at 193.
60. *The Times* (London) 15 December 1910 at p.3.
61. *Ibid.*; see also 28 R.P.C. 181 at 212.
62. 28 R.P.C. 181 at 193.
63. *Ibid.*
64. British Patent No. 29,505 of 1897.
65. British Patent No. 525 of 1898.
66. *The Times* (London) 16 December 1910 at p. 3.
67. 28 R.P.C. 181 at 193.
68. British Patent No. 1,862 of 1899.
69. Cited 28 R.P.C. 181 at 208 - 209.
70. *The Times* (London) 16 December 1910 at p.3.
71. 28 R.P.C. 181 at 193; *The Times* (London) 16 December 1910 at p.3. The doubt which Swinburne raised as to whether Braun was acquainted with Marconi's work was to prove an Achilles' heel for the BRT & T Co Defence throughout the case. If, for example, the "well known vertical sending wire" referred to by Braun in his patent was not Marconi's aerial, and was merely a vertical wire of small inductance and small capacity,

this would produce a greater frequency of vibration. On the other hand if the reference was to Marconi's earthed aerial, Braun had decreased the frequency of the transmitting circuit without the corresponding decrease in the frequency of the receiving circuit. The inference in Swinburne's mind was clear in both cases; Braun had not intended to tune.

72. 28 R.P.C. 181 at 194; *The Times* (London) 16 December 1910 at p. 3.

73. 28 R.P.C. 181 at 194.

74. *Ibid.*

75. 28 R.P.C. 181 at 194; *The Times* (London) 17 December 1910 at p. 3.

76. 28 R.P.C. 181 at 194-195; *The Times* (London) 21 December 1910 at p.3.

77. 28 R.P.C. 181 at 195.

78. On Colefax see *The Law Times* 29 February 1936 at p.179; on Duddell see *Journal of the Institution of Electrical Engineers* Volume 58 1918 at pp.538-540; on Boys see *Electrical Trades Directory* ("The Blue Book") 1907 at p.xix.

79. Neville Maskelyne's career in wireless has never been fully explored but references to his exploits can be found in *Minutes of Evidence Taken before the Select Committee on Radiotelegraphic Convention* 25 April 1907 at pp.176-187, HMSO 1907 (a copy of which is held in Australian Archives (VIC) MP341/1; 1913/10091); *W.P. Jolly Marconi* 1972 at pp.92-93,140-143 and 150-15; J.E. Packer *The Spies At Wireless Point: The Eastern Telegraph Company and Marconi's Wireless Experiments in Cornwall* Porthcurno Occasional Paper No. 16 1991 at pp.4-5; Sungook Hong *Syntyony and Credibility: John Ambrose Fleming, Guglielmo Marconi, and the Maskelyne Affair* in J.Z. Buchwald (ed.), *Scientific Credibility and Technical Standards in the 19th and early 20th Century Germany and Britain* Kluwer Academic Publishers Great Britain 1996 at pp.157-176.

80. 28 R.P.C. 181 at 196.

81. Thorne L. Mayes *Wireless Communication in the United States: The Early Development of American Radio Operating Companies* The New England Wireless and Steam Museum 1989 at p.68.

82. 28 R.P.C. 181 at 198.

83. *Ibid.* at 196.

84. *Ibid.* at 197.

85. *Ibid.*

86. Baker, *op. cit.*, at p.128.

87. *The Times* (London) 19 January 1911 at p. 3.

88. 28 R.P.C. 181 at 198-199; *The Times* (London) 19 January 1911 at p. 3.

89. 28 R.P.C. 181 at 203.

90. *Ibid.*

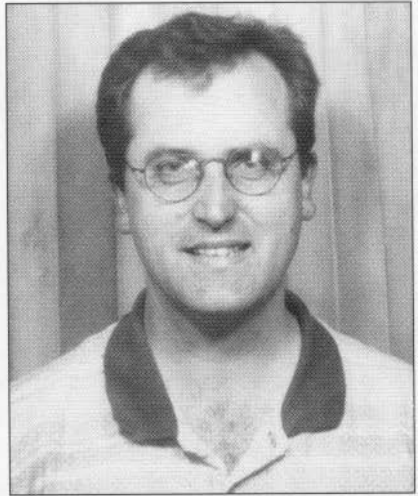
91. Referred to in a case summary in *Electrical Trades Directory* ("The Blue Book") 1911 at p.495.

92. 28 R.P.C. 181 at 204.
93. British Patent No. 12,326 of 1898.
94. British Patent Nos. 6,982 and 25,186 of 1899.
95. 28 R.P.C. 181 at 205.
96. Ibid. at 208.
97. Ibid.
98. Ibid.
99. Ibid. at 211.
100. Ibid.
1. Ibid. at 212.
2. Ibid.
3. Ibid.
4. Ibid. at 217.
5. Ibid. at 217-219.
6. Australian Archives (ACT) : A432/86 ; 29/2756 PT6 Papers ie. Shaw and Balsillie Patents and Dispute Part 6, Statement by J.G. Balsillie : Appendix G at p.2.
7. Public Records Office BT31 12850/10424 , Letter to the Registrar of Companies from George Pascoe Grenfell, 28 March 1911.
8. Public Records Office BT31 12850/10424 , Letter to the Registrar of Companies from George Pascoe Grenfell, 7 June 1911.
9. *The Marconigraph* April 1911 at p. 4.
10. *The Post Office Electrical Engineers' Journal* April 1911.
11. In the Matter of Lodge's Patent 28 R.P.C. 365.
12. Ibid. at 379.
13. *The Times* (London) 21 July 1911 at pp. 20, 22.
14. Australian Archives (ACT): A432/86; 29/2756 PT6 Papers ie. Shaw And Balsillie Patents and Dispute Part 6, Statement by J.G. Balsillie: Appendix G at p.3; *The Times* (London) 21 October 1911 at p.20; *New York Times* 4 November 1911 at p.7; *The Argus* (Melbourne) 1 December 1911 at p.12. See also S.G. Sturmeay *The Economic Development of Radio* Gerald Duckworth & Co. Ltd, London 1958 at pp.20-21 and Aitken, op. cit. at p.167.
15. *The Times* (London) 26 October 1911 at p.17. Litigation testing the 7777 patent did arise from time to time but was resolved on essentially the same grounds applied by Mr Justice Parker in *Marconi v. British Radio Telegraph and Telephone Company*; for example see *Marconi v. Helsby Wireless Telegraph Company* 31 R.P.C. 399 where Mr Justice Eve of the Chancery Division of the High Court of Justice held that the addition of two spark gaps in a tuning circuit constituted a breach of the 7777 patent.
16. *New York Times* 22 February 1911 at p.4.
17. Ibid.
18. See Douglas, op. cit. n.138 at p. 344.
19. Ibid. at pp.184-185.

20. *New York Times* 21 February 1912 at p.4.
21. *New York Times* 17 March 1912 at p.6.
22. *New York Times* 18 March 1912 at p.5.
23. *Ibid.*
24. *New York Times* 26 March 1912 at p.15. On the same day an action by American Marconi against the New England Navigation Company in the United States District Court was also discontinued indefinitely prior to Marconi appearing in the case to give evidence in relation to U.S. Patent 763,772. Aitken, *op. cit.* at p.283 refers to a 'decision' in the 1912 United Wireless case which is not strictly correct as the matter was not determined by the court at this time.
25. See Mayes, *op. cit.*, at pp.69-70,109-110.
26. *Marconi v. Siemens Bros & Co. Ltd* 29 R.P.C. 146.
27. *Marconi Wireless Telegraph Co. of America v. National Electrical Signaling Co.* 213 Federal Reporter 815.
28. *Societe Marconi v. Societe Generale*, etc , Civil Tribunal of the Seine, 3rd Chamber, 24 December 1912 cited in *Marconi Wireless Telegraph Company of America v. United States* 320 United States Reports 1 at 64.
29. *Marconi's Wireless Telegraph Company Ltd v. Commonwealth* 15 Commonwealth Law Reports 685; *Marconi's Wireless Telegraph Company Ltd v. Commonwealth* [No.2] 16 Commonwealth Law Reports 178; *Marconi's Wireless Telegraph Company Ltd v. Commonwealth* [No.3] 16 Commonwealth Law Reports 384.
30. *Marconi's Wireless Telegraph Company (Ltd) v. Huddart Parker & Company Pty (Ltd)* (1912) 31 New Zealand Law Reports 499, *Marconi's Wireless Telegraph Company (Ltd) v. The King* (1912) 31 New Zealand Law Reports 732.
31. *Marconi Wireless Telegraph Company of America v. United States* 320 United States Reports 1; see also O.E. Dunlap *Radio's 100 Men of Science: Biographical Narratives of Pathfinders in Electronics and Television* Armed Services Inc.(by Arrangement with Harper and Brothers) 1944 at pp.197-198.
32. See Australian Archives (ACT): A2911/1; 1411/1911 Wireless Telegraphy-Appointment of J.G. Balsillie as Wireless Expert, Letter of Application by J.G. Balsillie at p.1; Australian Archives (ACT): A432/86, 29/2756 PT 6 Papers ie. Shaw and Balsillie Patents and Dispute Part 6, Statement by J.G. Balsillie: Main Statement A at pp.1-2.
33. Australian Archives (ACT): A432/86; 29/2756 PT 6 Papers ie. Shaw and Balsillie Patents and Dispute Part 6, Statement by J.G. Balsillie: Appendix G at pp.1-2.
34. *The Argus* (Melbourne) 27 July 1911 at p.9.



Graeme Bartram  
New South Wales  
Australia



Graeme Bartram is a graduate in Arts and Law from the University of Sydney and currently works in the area of labour relations for a major international company. In between raising an energetic two year old daughter with his wife, Joanne, he is researching the life and work of the Australian engineer and inventor J. Graeme Balsillie.

This article is dedicated to the memory of the late Pat Leggatt who reviewed earlier drafts and whose incisive criticism helped shape the final product.

Graeme is interested in furthering his research on Balsillie as well as early wireless telegraphy and may be contacted by E-Mail at [graeme.bartram@bigpond.com.au](mailto:graeme.bartram@bigpond.com.au) or by mail at 45 Marine Drive, Oatley, New South Wales, Australia 2223.

## MARCONI'S TRANSATLANTIC TRIUMPH — a skip into history

Bartholomew Lee  
San Francisco, CA

On the afternoon of December 12, 1901, Guglielmo Marconi heard the first radio signals (three "dots" of Morse Code) to cross the Atlantic Ocean. The Morse "S" of three dots was transmitted from England to Newfoundland using his new system of wireless telegraphy.<sup>1</sup> Graphics of Marconi's calendar [19], and that of his assistant, George Kemp [14], noting date and time they heard the pre-arranged signals, are reproduced here. (Fig. 1) Marconi noted "Sigs at 12:30, 1:10 and 2:20." Kemp notes "Got Sigs 3 Dots" and of their 500-foot long kite antenna "... kept it up three hours which appeared to give sigs good." (Fig. 2)

Figure 3 is an artist's conception of the lofting of that kite [13]. The antenna wire from which the kite flew was then affixed to a pole from which the kite remained aloft (Fig. 4) [16]. The site in Newfoundland, known as Cabot Tower, Signal Hill, is commemorated on a 1930s postage stamp (Fig. 5) [17].

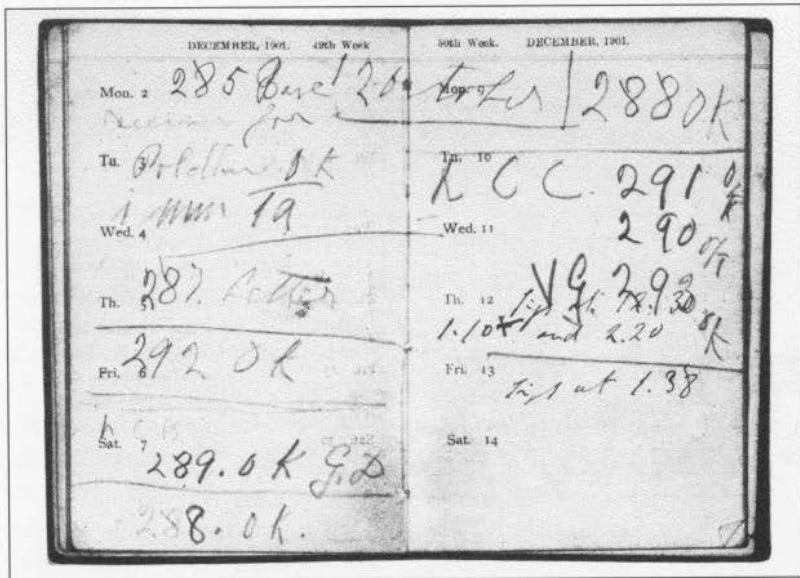
Marconi thus opened the century of telecommunications. One hundred years has brought even hand-held transceivers (ironically, Nikola Tesla's dream) linking to the world's telephone systems. The world now enjoys world-wide, high-bandwidth data, video and voice links including broadcasting. Parabolic antennas, pioneered by Marconi [15], listen to radio telemetry from deep space probes.

It is, however, not at all clear, even now, how Marconi's spark signals managed to get across the Atlantic, from Cornwall in England (at Poldhu on the Lizard Peninsula) to St. John's in Newfoundland, more than 1,800 nautical miles, in the middle of the day. The leading authority, Professor Hugh G. H. Aitken in *Syntony and Spark*, notes the apparently poor propagation conditions, by most modern understandings of the phenomena: "... the transmission times and frequencies were, as later learned, the worst possible in view of propagation conditions on the North Atlantic path." [2]

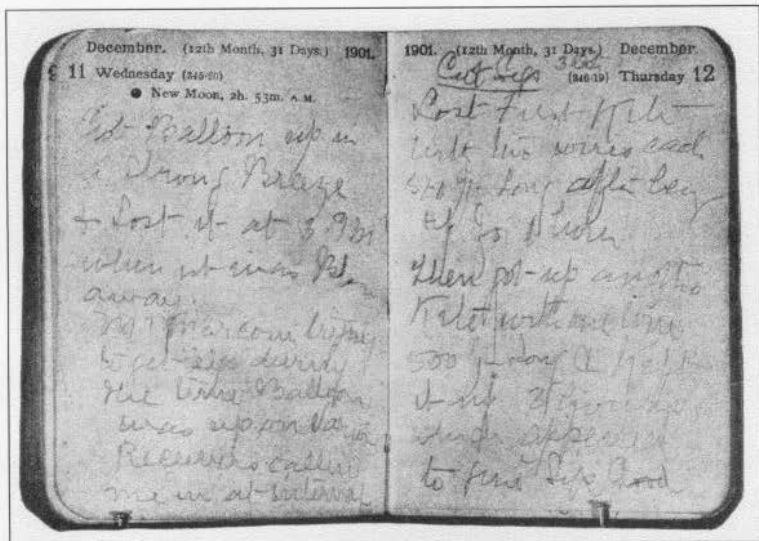
Daylight does not promote propagation of Marconi's system of relatively low-frequency, long-wave wireless. Marconi himself found this out the next year. Using an inker and coherer for reception, he could no longer

---

<sup>1</sup>Marconi's story is, of course, well known. See, e.g., Baker, *A History of the Marconi Company*, [4] and Aitken, *Syntony and Spark, The Origins of Radio*, [2] at Ch. 5. It is perhaps most accessible in the 1984 illustrated pamphlet from the Marconi Company, compiled by Pam Reynolds, titled *Guglielmo Marconi* [19].



**Figure 1.** Page from Marconi's diary for December 12, 1901. In it he recorded the reception at Signal Hill of the three dots of the Morse code "S" being transmitted from Poldu in England.

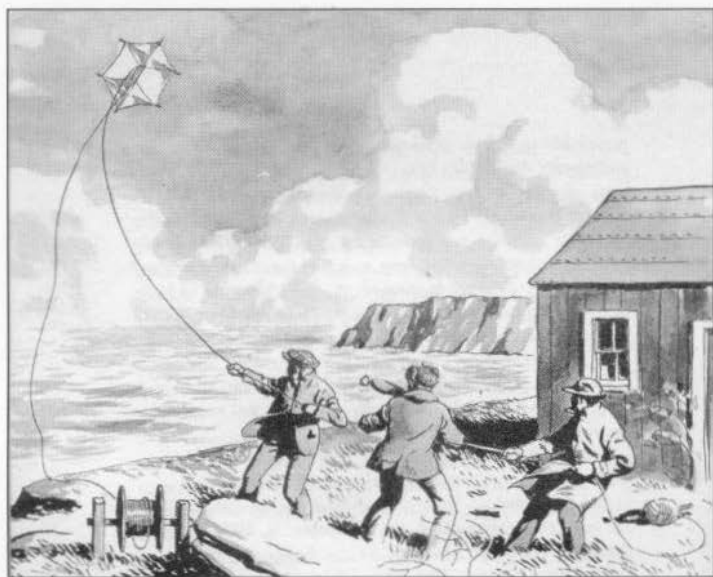


**Figure 2.** Pages from the diary of George Kemp, Marconi's assistant, for December 12, 1901, recording the reception of the first transatlantic signals from England; "Got Sigs 3 Dots."

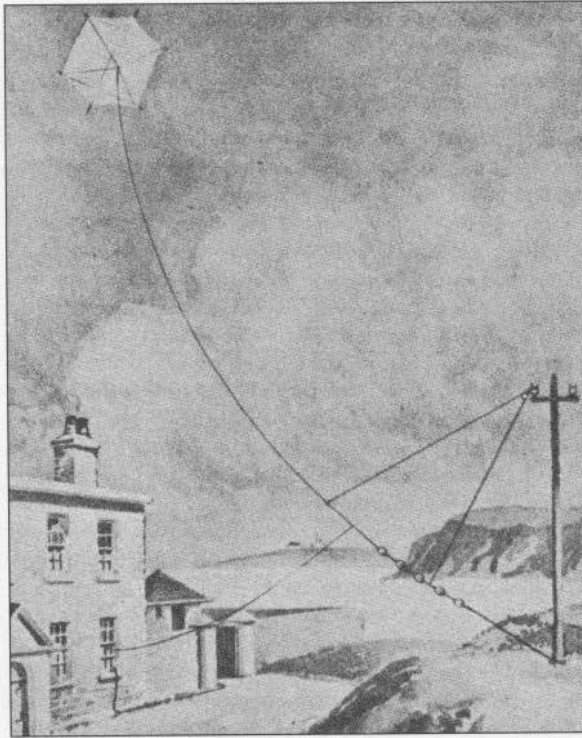
record signals at sea at 700 miles, as he later recalled in his 1926 article *Looking Back Over Thirty Years of Radio* [14]. Yet, on that same 1902 voyage on the *S.S. Philadelphia*, Marconi replicated the more than 1,800 miles distance from Poldhu to St. John's with shore-to-ship reception, but only at night, reaching out 2,099 statute miles [14, 19]. He had thus first identified what he called this "night effect." Soon enough, higher power and longer wavelength stations regularly crossed the oceans.

Later familiarity with short-wave propagation by reflected sky wave has led to some speculation that perhaps Marconi managed to hear a high-order harmonic of his transmitter's fundamental frequency. This note will look at propagation conditions for the afternoon of December 12, 1901. Those conditions, taken together, suggest that Marconi enjoyed a rare confluence of circumstances. Unusual propagation conditions permitted his first transatlantic signaling on his likely fundamental frequency or close to it. Conversely, higher order harmonic propagation is unlikely.

The first issue is the frequency on which Marconi's Poldhu transmitter (Fig. 6) operated. The very question is misleading. A spark transmitter works by production of a radio frequency hash. This emission centers on a band of frequencies around its inductance- and capacitance-determined resonant-peak frequency. Perhaps the most widely known contemporary explanations of this technology are in Marconi engineer Elmer Bucher's 1917 *Practical Wireless Telegraphy* [6] and the U.S. Navy's *Robinson's Manual of Radio*



**Figure 3.** *The antenna supported by the kite at Signal Hill, Newfoundland, used on December 12, 1901 to receive the signals from Poldhu.*



**Figure 4.** *The station location at Signal Hill, where Marconi set up his instruments for the historic first reception of the transatlantic signals.*



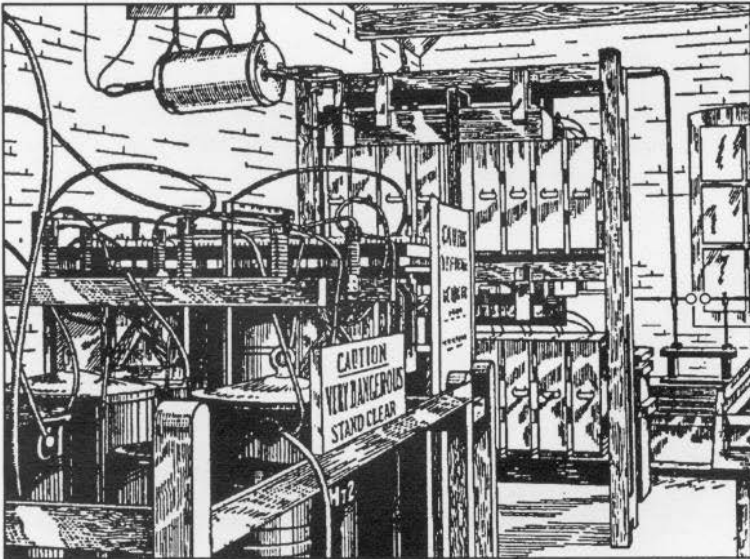
**Figure 5.** *The 1930s Newfoundland postage stamp showing the Cabot Tower at Signal Hill, St. Johns.*

*Telegraphy* [20]. The bandwidth of the hash is great, and measured logarithmically in terms of its “decrement” or spread [6]. Moreover, the antenna system often, if not usually, resonated on a different frequency. This “coupling” mismatch resulted in a second peak of a second band of frequencies, usually of a shorter wavelength than the transmitter’s peak [20]. Engineers came to call this condition a “double hump” because it looked like a camel’s back when graphed [20]. An illustration (Fig. 7) from Bucher’s book shows the graphs resulting from close coupling an antenna to a transmitter [6]. It would be only in the period before the First World War that techniques of tuning regularly focused the radio-frequency energy of spark transmitters into a single relatively sharp peak [20]. Marconi enjoyed no such precision in 1901.

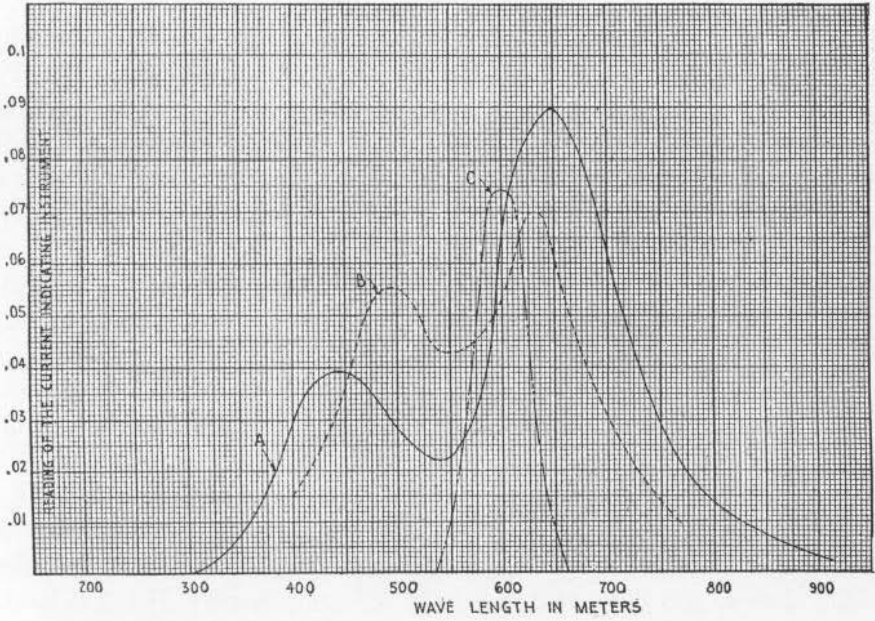
Marconi had set up a large antenna array of circular form to put his 25,000 watt spark signal into the ether; an illustration appears in Fig. 8 [16]. A storm took it down shortly before the tests, perhaps providentially. He then put up a jury-rigged antenna of about fifty nearly vertical wires in a narrow fan, illustrated in Fig. 9 [19]. The more fully reconstructed shoreside Poldhu site<sup>2</sup> is also illustrated in Fig. 10 for comparison [12]. It is likely that the resonant characteristics of the new antenna differed significantly from the earlier version, and likely that its resonant frequency was higher, because it was so much smaller [2]. This circumstance lends itself to a

---

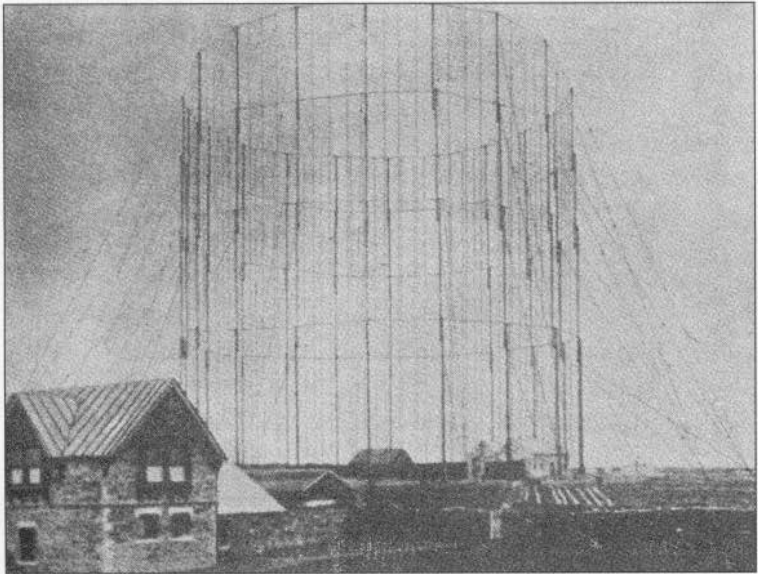
<sup>2</sup>“Poldhu is the name of a small cove on the western side of the Lizard Peninsula, which has become one of the best known places in Cornwall [circa 1912], since the erection of Signor Marconi’s telegraph station...” [12]



**Figure 6.** *The transmitter at Poldhu in Cornwall, England from which the first transatlantic wireless signals were sent in December, 1901; (after a contemporary photograph, artist unknown).*



**Figure 7.** Graph showing the effect of changing the coupling from the oscillation transformer to the antenna.



**Figure 8.** The large circular antenna structure originally erected at Poldu, Cornwall, for the transatlantic tests.

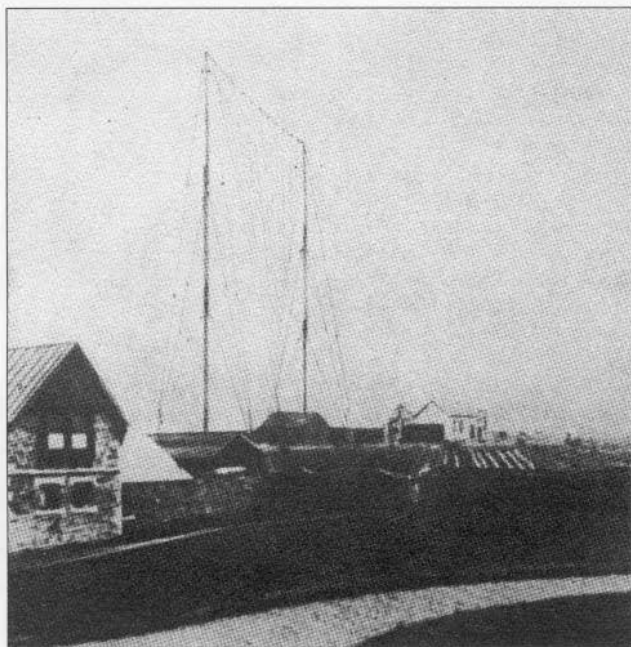
second, higher-frequency peak band being transmitted along with a fundamental peak band of frequencies. Moreover, the emitted radio-frequency electromagnetic waves perhaps took on a vertical polarization because of the accidental antenna configuration, which, if maintained, would have been good for reception by the kite wire.<sup>3</sup>

Still, the fundamental frequency is not known. Reports are 820 kilocycles per second (kilohertz, or kHz) (366 meters) and 100 kHz (3000 meters), a full order of magnitude disparity [2]. The 366 meter conclusion is that of H.M. Dowsett, a Marconi engineer at the time [2], as well as Marconi's later, 1908 report [4]. Harmonics and what were later called spurious and parasitic emissions were inherent in the nascent technology. Poldhu's signals were likely all over the ether, what would now be called the radio-frequency spectrum. On the other hand, there was hardly anyone to interfere with (perhaps only Tesla), and no one else "on the air" that winter day. Marconi's receiving circuits tuned very broadly, optimizing the chance of reception.

Engineers use the term "propagation" to describe the processes by which radio signals travel, particularly through the atmosphere. High-frequency propagation is mediated by the state of the ionosphere between the transmitter

---

<sup>3</sup>This is so because both the temporary transmitting antenna array and the kite-cable receiving antenna were in effect vertically polarized.



**Figure 9.** *The fan-shaped vertical antenna erected at Poldu as a replacement for the circular antenna shown in Fig. 7, which was destroyed by a storm.*





Figure 10. Another view of the reconstructed Poldu site, from a postcard.

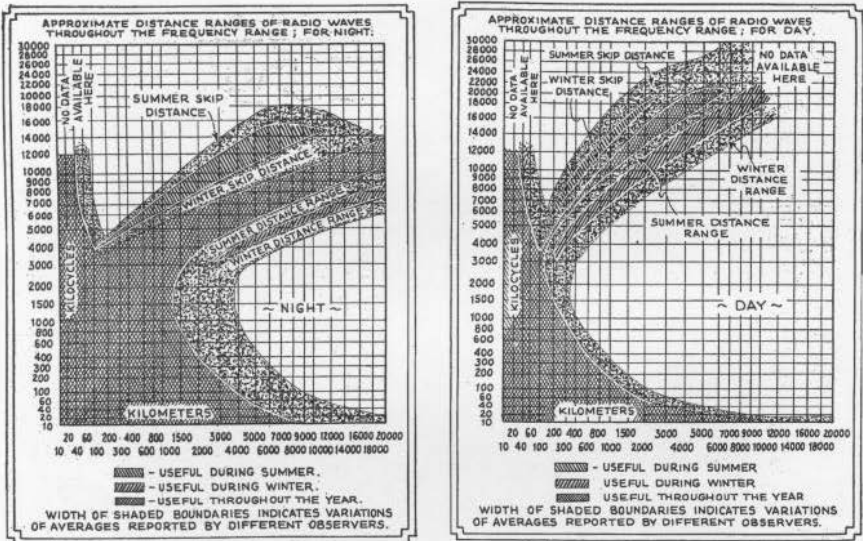


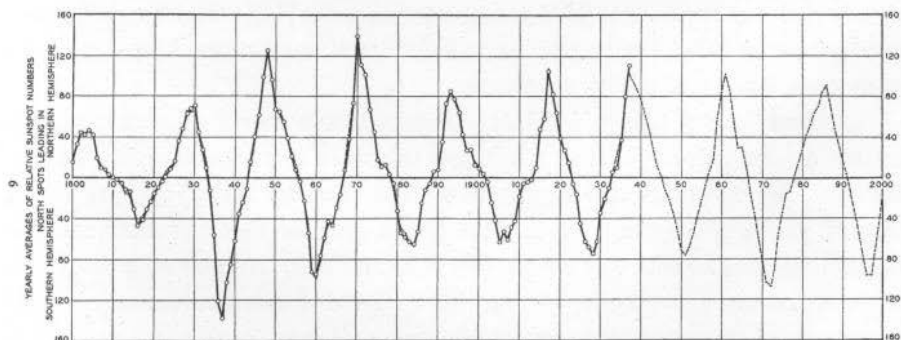
Figure 11. Frequency vs. distance graphs compiled by the U.S. Bureau of Standards in 1932. Abstracted from Short Wave Craft, July, 1932.

and receiver [5]. Modern concepts such as maximum useable frequency and minimum useable frequency were unknown and unanticipated in 1901. Indeed, they were not initially appreciated for another 25 years. Some of the earliest frequency *versus* distance curves, compiled by the U.S. Bureau of Standards in 1932, appears in Fig. 11 [10]. Marconi himself first came to believe that the longer the wavelength, the longer the distance possible for the same power and antenna height.

This is true enough, as the curves show, but misses the short-wave length, higher-frequency path of ionospheric “skip” propagation to which Marconi turned in the early 1920s, without identification of the physical mechanism. See, e.g., his 1924 article *Results obtained over very long distances by Short Wave Directional Wireless Telegraphy ...* [15]. Physicists Oliver Heaviside and Arthur Kenelly had suggested an ionosphere as early as 1902, but not until 1925 or so was the mechanism of reflection suggested [2]. It was primarily amateur radio operators who explored the 200 meters-and-down “wasteland” to which they had been consigned by law. These radio amateurs first realized the power of these shorter wavelengths to reach great distances, *circa* 1920-’21, according to Professor Aitken (and the American Radio Relay League) [2].

Intensity of ionization in the upper atmosphere depends on the amount of solar (primarily ultraviolet) radiation from the sun. With the coming of darkness the ionized layers, denominated D, E, F, etc., shift and merge. Thus both season and time of day play roles in successful radio propagation.

The amount of ultraviolet radiation depends in turn on the number of sunspots from which the ultraviolet radiation emanates. For several centuries, it has been known that sunspots increase and decrease in approximately eleven-year cycles. Observation shows spots increasing then decreasing



**Figure 12.** Sunspot records from a Bell System study, showing the situation in December, 1901. These are measured and computed sunspot numbers from 1800 to 2000 AD. The solid line represents measured values, while the dashed line is a computed projection from the measured values.

in one hemisphere of the sun, then increasing and decreasing in the other hemisphere of the sun. In times of high sunspot activity, the frequencies useable for ionospheric or "skip" propagation increase. In a good cycle, such as number 19 which peaked in 1957-'58, world-wide, low-power communications as high as 28 mHz (megahertz) (10 meters) and sometimes higher, are common. 1999-2000 is similarly a peak year with sunspots already averaging more than 110.

Conversely, when sunspot numbers are low, only the lower frequencies lend themselves to ionospheric propagation. A sunspot minimum is a good time, for example, for the 160-meter amateur band (1800 kHz) to open up to distant parts of the world. Optimal propagation obtains in a band of frequencies, often between three and thirty mHz, which is higher or lower depending on whether there are more or fewer sunspots. The lower limit is known as the absorption frequency and the upper the maximum useable frequency. Frequencies either side of three to thirty mHz are, however, often useable at the valleys and peaks of the sunspot cycle.

Examination of sunspot records for a century ago shows a nearly unique datum: *on December 12, 1901 the number of sunspots was exactly zero, a dead-low minimum.* It was a transition year between the sun's hemispheres. A chart from a Bell System study appears in Fig. 12 [1]. Solar ionizing radiation on the atmosphere was at a minimum. Thus useable frequencies for skip propagation, bounded at the lower end by the absorption frequency, would be at near absolute minima. A zero sunspot number means ionospheric propagation at the lowest frequencies the band of useable frequencies ever reaches.

This effect was noticed as early as 1931, with the refinement that the more northerly the path, the longer the useable wavelength (i.e., the lower the useable frequency), by as much as a ninety percent increase for upper latitude paths as opposed to 10% for equatorial paths [18]. Nighttime skywave propagation at 800 kHz is common under such conditions, albeit detected on modern high sensitivity receivers.

A Branly metal filings coherer, connected to a direct-current circuit to actuate a landline or marine telegraph inker, is a low-sensitivity device. Marconi, however, used a highly sensitive "Italian Navy" self-restoring coherer, really a mercury oxide detector, a drop of mercury between two conducting rods of iron or carbon. [4] Marconi also listened on a telephone earpiece, rather than employing an inker. He did this deliberately to take advantage of the telephone earpiece's much higher sensitivity, as well as the extraordinary sensitivity of the ear itself. (Within about a dozen years, wireless operators using galena crystal detectors alone, and they were not much more sensitive than the Italian Navy coherer, would copy spark signals occasionally several thousand miles distant.) The historical price Marconi

paid in 1901 was the absence of an inker's paper record, a fault he remedied in 1902 on the *S.S. Philadelphia*, but at the price of reduced sensitivity.

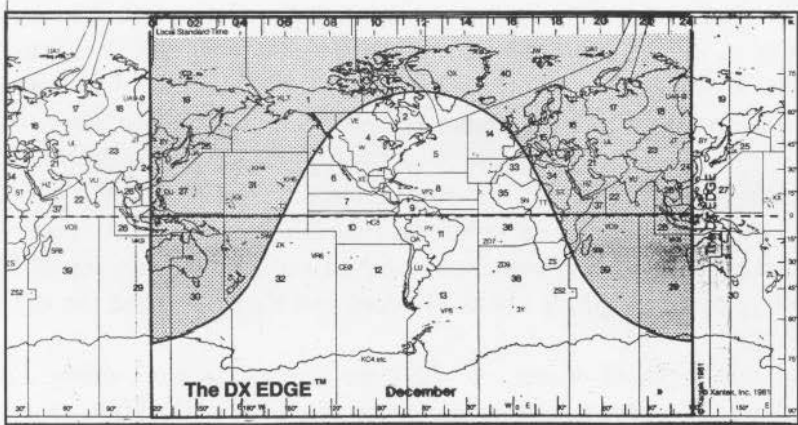
The season and time of day also lend themselves to enhanced lower-frequency propagation. December 12 is within 10 days of the winter solstice, leaving the Northern Hemisphere in maximum darkness. At this time of year, the thunderstorms of the tropics and temperate latitudes are farthest away. The likelihood of noise interference is minimum. Through an Italian Navy coherer, lightning-generated random static would not sound like the repetitive pattern of three clicks Marconi and Kemp listened for, the Morse Code "S."

At this depth of winter, the days are shortest as well, minimizing the cumulative effects of solar radiation on the lower, blocking, ionospheric layers. The lower, D, layer results from solar x-rays. It usually blocks reflection or refraction of radio waves or "skip," by the E or F layers above it. The winter D layer would have been relatively weak during the short day, having had less time to build. Moreover, Marconi himself noted in 1924 regarding his 3.25-mHz (92-meter wavelength) tests: "... the intensity of the signals vary... inversely in proportion to the mean altitude of the sun when above the horizon." [15] He is likely reporting a "D" layer phenomenon.

Newfoundland and Southern England are at about 50 degrees North latitude; the arctic circle is at 66.7 degrees North. Winter sunlight at this latitude is very low angle, even at Noon, is well filtered atmospherically and thus also less destructive of nighttime ionization patterns, especially to the North. Marconi noted the effect in his 3.25-mHz short-wave tests of 1924, out to 1,400 miles at sea: "... the signals' intensity is symmetrical to the mean altitude of the sun at all times...." [15]; in other words, the further North, the stronger was the reception.

Day and night come as sunrise and sunset, but from a global perspective, dawn moves around the world followed by sunset. The edge of daylight or darkness is often called the "terminator." It is necessarily a great circle, the light of the sun on a revolving Earth. As the axis of the Earth points towards the sun in summer, the terminator extends up to the far side of the arctic circle (the "midnight sun" phenomenon). Then, in winter, the terminator is tangent to the arctic circle, leaving the polar region without any daily winter sun.

The terminator may be visualized on a Mercator or similar projection map of the Earth as an inverted "U" shaped curve in winter. Radio propagation along the terminator is often enhanced by apparent refraction and long path "ducting." This phenomenon is familiar to amateur radio operators and short-wave listeners as "gray-line" propagation. It is experienced more as a band rather than a sharp line, with signals intensifying, peaking and then diminishing as the terminator approaches and then recedes. On the afternoon



**Figure 13.** *The DX EDGE™ propagation mapping system for December.*

of every December 12, including 1901, the gray line runs just west of England and well west of Newfoundland. Between 12:30 PM and 2:20 PM both the Poldhu, England transmitter and the St. John's, Newfoundland receiver were within a few degrees of the terminator, with Poldhu on the sunset side. See the accompanying illustration (Fig. 13) using the DX EDGE™ propagation mapping system [9].

Marconi thus enjoyed

- 1) an optimal solar season of zero sunspots for enhanced lower frequency and daytime propagation,
- 2) an optimal Winter season of minimal atmospheric noise and as well as enhanced daytime propagation, and
- 3) a good time of day at his latitude for gray line propagation.

That Marconi heard the three clicks of his coherer in his telephone receiver earpiece has always been a matter of faith in the integrity of the man [2, 4], true enough borne out by all later successes. Yet Marconi could hardly have chosen a better time or place to make his attempt, knowing as he did that the human ear is a very sensitive instrument.

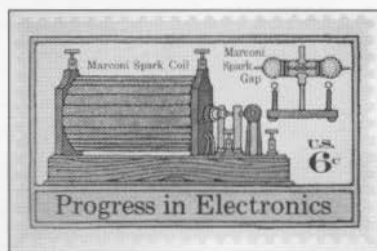
Recent work on radio propagation suggests the importance of these aspects of Marconi's triumph. In 1991 a group of experimenters traveled to St. John's, Newfoundland in November to listen for distant signals ("DX") in the broadcast band, 500 kHz to 1600 kHz, or roughly 600-meters to 200-meters wavelength, bracketing Marconi's likely 366-meter wavelength and 820-kHz frequency. With modern receivers and long-wire Beverage antennas, and despite auroral interference, even low-power stations in Europe, South America and Africa provided "a tidal wave of transatlantic DX" to the radios at St. John's, confirming that "the best medium wave location is next to the ocean." [8].

**Figure 14.** Face of a present-day French phone card imbedded with a silicon chip, showing Marconi.



**Figure 15.** Face of a 2000 lira Italian banknote, commemorating Marconi.

**Figure 16.** The 1973 US postage stamp, showing the Marconi apparatus.



Recent research also suggests that at lower frequencies (circa two mHz) signals from a transmitter newly within the sunset terminator may be enhanced for a receiver on the other side of the terminator [7], which was the situation between England after sunset and Newfoundland, between local 12:30 PM and 2:20 PM, at 50 degrees North in December. This is sometimes attributed to the temporary formation, just behind the terminator of an "F layer" in the ionosphere, providing a reflecting or refracting surface for low frequencies across the terminator into the areas not yet in sunset or darkness [7]. Such conditions, if indeed they did obtain on December 12, 1901, would have provided yet another etheric facilitation of the one skip needed by Poldhu's three dots to get the 1800 miles to St. John's and into history.

Marconi's achievement is still celebrated in many ways; two of the most interesting are a French "phone card" (Fig. 14) with a silicon chip on it [11], and on Italian money (Fig. 15) [3]. The United States Postal Service also honored Marconi in 1973 (Fig. 16) [21].

### Sources and Notes

[listed alphabetically, inner citations also alphabetical]:

1. Anderson (C. N.), *A Representation of the Sunspot Cycle*, Bell Telephone System Radio Monograph B-1139 at 6; also XVIII Bell System Technical Journal 292 (April, 1939). The exact sunspot number of *zero* for December, 1901 is available from the NASA archive: [www.science.nasa.gov](http://www.science.nasa.gov) and most specifically, [http://science.msfc.nasa.gov/ssl/pad/solar/greenwch/spot\\_num.txt](http://science.msfc.nasa.gov/ssl/pad/solar/greenwch/spot_num.txt)

2. Aitken, Hugh G. H., *The Continuous Wave — Technology and American Radio, 1900 - 1932*, John Wiley & Sons, 1976; Princeton Univ. Press, 1985:

Amateur priority on short waves, at 512 and n. 53

*Syntony and Spark — The Origins of Radio*, John Wiley & Sons, 1976; Princeton Univ. Press, 1985

Dowsett, at 296 in n. 89; Baker [4] says Marconi agreed, at 71 fn.

Integrity of Marconi, at 295 at n. 86, citing [4] Baker at 71

Ionosphere and reflection, at 243

*Marconi*, Chapter 5 at 179ff

Propagation at its worst, at 295 in n. 86; *accord* Baker [4] at 71

Smaller wire array antennas resonate at higher frequencies, at 267

Wavelengths for 1901 test, at 269

3. Banca D'Italia, *Duemila Lire* (2,000), October, 1990. Marconi's yacht *Y.S. Elletra*, a magnetic detector and a four tower wireless station appear on the reverse. Marconi also appears on the obverse of two Italian coins.

4. Baker, W. J., *A History of the Marconi Company*, London, Methuen & Co., 1970, New York, St. Martin's Press, 1971

Integrity of Marconi, at 71

Italian Navy coherer, at 68

Propagation at its worst, at 71

But was the coherer in Newfoundland self-restoring? "Suddenly, there sounded the sharp click of the 'tapper' as it struck the coherer, showing me that something was coming" Marconi is reported to have recalled later. See Giancarlo Masini, *Marconi*, 1976, [translation in English, 1995, Marisilio Publishers, New York], at 158, quoting unsourced but apparently written "recollections" of Marconi of the events of December 12, 1901.

5. Brown (Robert R.), *A Brief History of Ionospheric Studies*, Fine Tuning's Proceedings, 1994-1995, at P6.1ff; see also Ian Poole, *Radio Waves and the Ionosphere*, *QST Magazine* (November, 1999) at 62.
6. Bucher, Elmer E., *Practical Wireless Telegraphy*, Wireless Press, 1917  
Decrement §169 in Part XI Practical Radio Measurements, at 200  
"Double hump" graph of wavelengths, at §182 at 219  
Marconi engineer, title page, at [i]
7. Clark (David) and John Bryant, *Additional Notes on Tropical Band Propagation*, Fine Tuning's Proceedings, 1991, at P4.1ff
8. Connelly, (Mark; WA1ION), *The Newfoundland 1991 Medium Wave DXpedition*, Fine Tuning's Proceedings, 1992-1993, at F32.1ff
9. DX EDGE™ copyright Xantek, Inc. 1981 using the Miller Cylindrical Projection and a different sliding terminator overlay for each month of the year
10. [Editors], How Far on What K-C [kilocycle, kHz]? *Short Wave Craft*, July, 1932, 160. This graph exactly predicts Marconi's 1902 night distance of 2,000 some odd miles, assuming a frequency of 800 kHz and comparable sensitivities in receivers
11. France Telecom, *Télécarte 50*, Guglielmo Marconi (1874-1937), *Les Grandes Figures Des Telecommunications*, which goes on to say, in French, that Marconi "... primed the birth of wireless telegraphy [*la TSF*] by copying his first signals in 1896 [and that] in 1901, he sent the first radiotelegram between England and the New World"
12. Gillette (artist), painting of Marconi Telegraph Station and Poldhu Hotel..., Tuck's Post Card No. 7740, circa 1912
13. Lee (Manning DeV.) (artist), drawing of kite lofting, in Joseph Cottler, *Marconi*, Calif. State Department of Education, 1956, at 28
14. Marconi, Guglielmo, Looking Back Over Thirty Years of Radio, *Radio Broadcast*, November, 1926 at 28  
700 and 2200 miles on *S.S. Philadelphia*, at 29 (see also  
LXX Proceedings of the Royal Society, June 12, 1902)  
Kemp's calendar, at 29

Marconi's earliest theory of propagation may be found, curiously, in a 1901 story by Rudyard Kipling titled "Wireless" in *Mrs. Bathurst and Other Stories* (ed. Lisa Lewis, in *The World's Classics*, Oxford, 1991 at p. 23). Marconi had visited Kipling at his home in 1899 and explained how signals penetrated the ether. Kipling opens his story with dialogue starting "It's a funny thing, this Marconi business, isn't it?" Later, he quotes the wireless operator: "Grand, isn't it? That's the Power — our unknown Power — kicking and fighting to get loose," said young Mr. Cashell. "There she goes — kick — kick — kick into space..." I am indebted to Professor Thomas Gavin for his insight and initiative in making this material available to me.



15. Marconi, Guglielmo, *Results obtained over very long distances by Shortwave Directional Wireless Telegraphy more generally referred to as The Beam System* — paper read at the Royal Society of Arts on the 2nd July, 1924 by Senator Guglielmo Marconi... Reprint from the Journal of the Royal Society of the Arts [privately, presumably for the Marconi Company]

Altitude of the sun, at 6 (seasonal), 8 (daily)

Parabolic reflectors, at 4, Fig. 3

It was Marconi's deep conviction that the explorer of a new technology should always reach beyond the limits suggested by the "experts" of the day, and not permit such expertise to constrain experiment or ambition.

16. McNichol, Donald, *Radio's Conquest of Space*, Arno Press reprint, 1974 of Murray Hill Books, 1946

Poldhu circular antenna, illustrated at 138

Kite antenna, illustrated by an unidentified artist, attributed to

Radio Corporation of America, at 140.

17. Newfoundland [Postal Authority], 1937 green nine-cent postage stamp of Cabot Tower on Signal Hill, noting: "First Trans-Atlantic Wireless Signal Received [in] 1901"

18. Noack, (F.), How Sun Affects S-W [Short Wave] Reception, *Short Wave Craft*, December, 1932, 400 at 507

19. Reynolds, Pam, *Guglielmo Marconi*, The Marconi Company, 1984.

Jury rigged fan antenna, at 9, item 21(photo); Baker [4] says 50 wires, at 66, Fig. 6.2 but the photo suggests fewer

Marconi's calendar, at 10, item 22

*S.S. Philadelphia* 1902 tests, at 10, items 23, 24

20. Robinson, Capt. S.S., Capt. D. W. Todd, and Cmdr. S.C. Hooper, *Robinson's Manual of Radio Telegraphy and Telephony ...*, Annapolis, U.S. Naval Institute, 1919

Graphs of double hump wavelength emissions,

at 242 see Fig. 135, and at 250 see Fig. 139

Humps of differing wavelengths, at 238

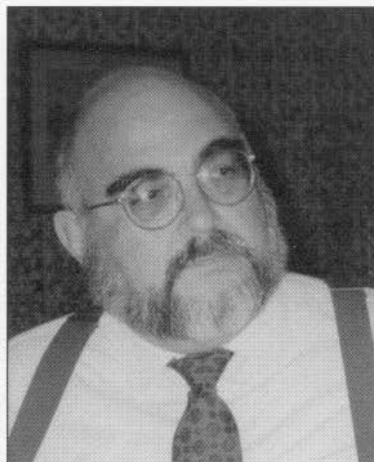
Shorter wavelength for second hump, at 238

Tuning for sharp peaks, at 239ff

21. United States Postal Service, six-cent multicolor postage stamp of the 1973 series (of four) denominated "Progress in Electronics," designed by Walter and Naiad Einsel, illustrating a Marconi induction coil and an early spherical spark gap

[END]

BARTHOLOMEW LEE  
Attorney at Law,  
Adjunct Professor,  
Golden Gate University  
595 Market Street, ste 1350  
San Francisco, CA 94105  
Phone 415 956 5959  
Fax 415 362 1431  
blee@slksf.com  
KF6YWU — xWPE2DLT



Correspondence is invited.

Bartholomew Lee is a lawyer who has enjoyed an international practice and radio-related activities around the world. Bart is also an Adjunct Professor at a San Francisco university, most recently teaching courses in the economic history of telecommunications and in law. Over the last several years, he has made presentations to the A.W.A. and published on the history of short-wave radio, radio as a tool of intelligence work, and early wireless on the West coast. For many years he has been active with the California Historical Radio Society and the electronics Museum of the Perham Foundation. Most recently Bart has been working with the California Office of Emergency Services as newly-minted KF6YWU.

## RADIO DIRECTION FINDING AND "HUFF-DUFF"

**Richard C. Foster**  
Cochituate, MA 01778

and

**Pierre Demerseman**  
Paris, France

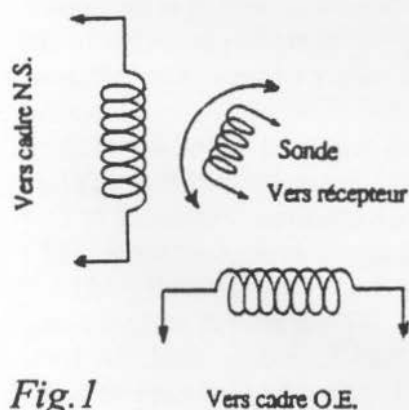
On March 27, 1944, Admiral Ernest J. King, Chief of Staff of the U.S. Navy, gave to Navy Secretary J.V. Forrestal a report concerning military operations up to the first of March of the same year.<sup>1a</sup> As it happens the date of signature of this report coincided with the hundred-fiftieth anniversary of an act of Congress deciding the construction of the first great warships of the U.S. Navy. In a paragraph concerning the anti-submarine struggle, Admiral King wrote, "It is unfortunate that we can give here no details on our operations against submarines... It is of critical importance that we should leave our enemies in ignorance of our techniques for fear that they might profit from them for operations against our own submarines. The submarines have not been hunted down to the very last, but after having constituted a threat, they are now no more than a problem."<sup>1b</sup>

Exactly what were the "techniques" evoked so secret that the admiral abstained from giving the slightest information in his report? It brought together three sources of information on the positions of wolf-packs of U-Boats which put the allied convoys in the Atlantic in great peril.<sup>2</sup> A very detailed analysis principally concerning Huff Duff, was published recently in the excellent and very well documented work (155 references), of Kathleen Broome Williams, entitled "Secret Weapon."<sup>3</sup> These three sources were: the deciphering of German radio messages encoded by the Enigma machine and decoded by the allies from the very beginning of the conflict;<sup>3-6</sup> the utilization of shipboard centimetric radar;<sup>3-5, 7, 8</sup> and instantaneous radio-direction finding on short waves or Huff-Duff (two phonemes for HF-DF or High Frequency Direction Finding). The simultaneous use of all three of these means of search allowed the development of new offensive tactics against submarines, which brought about a reversal of the military situation in the Battle of the Atlantic.<sup>3</sup>

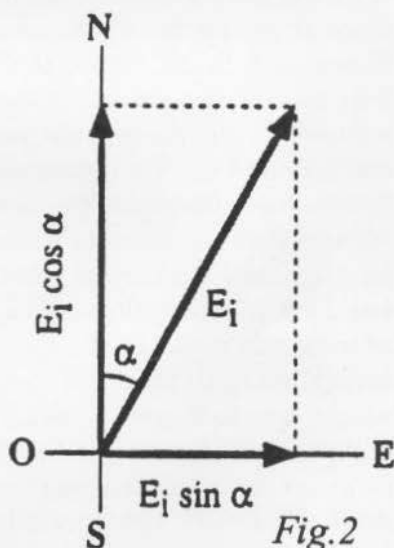
The secret of Huff Duff was revealed during a press conference organised by the US Navy and ITT on January 12, 1946 and was taken up by a number of newspapers, in particular *The New York Times*, two days later.<sup>3</sup>

Radio direction finding is almost as old as wireless. The use of loops allows freedom from static and other bothersome radio waves that the first receivers, which had very little selectivity, could not separate out. Numerous developments came along, notably for naval and air navigation, for the goal was the damping of the received signal, which furnishes greater angular precision because of the logarithmic character of the sensitivity of the human ear. Detection was not instantaneous, but this is not particularly important when the emitting stations are "cooperative." With stations that are "noncooperative" like those used in case of conflict (very short emissions, and frequent changes of frequency) the directional detection by classic orientable loops is long, chancy, and quite difficult on the short waves. It is for this reason that, from the very beginning of the century, numerous countries tried to perfect radio direction finding in order to make it easier to use, more precise, and more rapid.

In 1907, Bellini and Tosi perfected a radio direction finder using two large fixed loops, whose dimensions (of the order of 25 meters on each side) made rotation difficult.<sup>9-14</sup> The two identical loops have symmetrical orientation in relation to their vertical common axis, a 90-degree relation to each other. Each loop is tied to a coil which is tuned, and the two coils are disposed, (like the loops) perpendicularly. A third coil, which is also tuned, termed the probe, can turn about an axis aligned with the common axis of the two other coils, thus making a variocoupler with crossed stators (see the schematic representation in Fig. 1). The two coils N-S and E-W each receive the high-frequency radiation picked up by their corresponding loops. These



**Fig. 1** The 1907 Bellini and Tosi radio direction finder, showing the two loops and the coil.

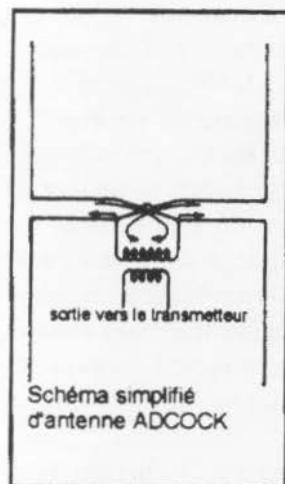


**Figure 2.** Vector diagram of the signals picked up by the Bellini and Tosi circuit.

signals are Figs. 1 and 2 respectively, proportional to the cosine and the sine of the angle  $\alpha$ , the angle of arrival of the energy  $E_1$  (vector representation: see Fig. 2).

Obviously, the graduated dial, which is fixed to the axis of the probe coil, must be aligned with the compass orientation of the fixed loops. A mathematical analysis can be found in the paper of R. Messny<sup>12</sup> and a theoretical and practical analysis in the recent work of A.O. Bauer.<sup>15</sup> As for the 180-degree doubt inherent in reception by a loop, it can be resolved by the utilisation of an auxiliary antenna whose signals cause either a reinforcement or a weakening of the maximum signal as a function of the two possible orientations of the loop. The Bellini-Tosi radio direction finders were used by the French army during the First World War to pick up the position and the route of the Zeppelin dirigibles which emitted at regular intervals in order to be able to receive their coordinates from German radio direction finding stations on the ground.<sup>11</sup> The crossed variocoupler with a turning probe was manufactured by Ducretet.<sup>14</sup> The criterion of ease of use mentioned above was thus attained at least partly, although the assembly and the mechanical resistance of the loops were not without problems.

After the Armistice of 1918, most of the work in this field was aimed at navigation and the locating of storms for the needs of meteorology. Between 1920 and 1930 great progress was made throughout the world in the area of radio direction finding at frequencies much higher than had been tried before. Beginning in 1923 R. A. Watson-Watt, the father of radar in England, perfected an instantaneous radio direction finder using as an indicator a cathode ray tube, whose pairs of plates,  $x, x'$  and  $y, y'$  received the amplified signals coming from two crossed loops. This arrangement dispensed with the turning probe coil and allowed direct visualisation of the emission on a screen.<sup>16</sup> Although it was not yet adapted to short waves, it allowed a glimpse of wider implications than those limited to navigation and meteorology. Its instantaneous nature could find application in the detection of emissions of a noncooperative nature of very short duration. Watson-Watt continued to work on his invention which led to a practical service model working on short waves. This was used by the Royal Navy and the R.A.F. from the very beginning of the Second World War. In place of loops this model used a system of Adcock antennas,<sup>17</sup> made up of four vertical masts of about ten meters high, arranged at the four corners of a square, whose diagonals, about ten meters long, were generally oriented north-south and west-east. (See Fig. 3)<sup>3,13,15,18</sup> This system of antennas only picks up the electrical component of the high-frequency field, the lead-down wires being very carefully shielded. It gives the advantage of being less sensitive than loops to "night effect" due to out-of-phase ionospheric reflections which can also influence the horizontal components, thus causing imprecise readings. However, the Adcock antennas in the frequency bands



**Figure 3.** *The 1919 Adcock antenna.*

*Authors' note: In its simplest form the Adcock antenna, invented in 1919, is made up of two separate vertical antennas connected as shown in Fig. 3.*

*Its action in regard to waves polarized vertically is exactly like that of a loop.*

*The spacing of the elements is not critical between 1/10 and 3/4 of its wave-length.*

*Two identical groups of antennas arranged perpendicular to each other on the diagonals of a square behave like two perpendicular loops in a Bellini-Tosi system.*

*Ref: Radio Engineering, F.E. Terman, McGraw Hill, 1947 and The ARRL Handbook, 1996.*

used in the 1940s were quite difficult to mount on naval ships because of their large size and also because of the unavoidable effect of the metallic masses that surround them on a ship. This is why two other versions were developed for use on board. Models FH3 and FH4 returned to the technique of small fixed crossed loops placed as high as possible on a mast which was often reserved strictly for them.<sup>3,15,19</sup> Model FH4, placed in service in October, 1941, allowed a visualization on a cathode ray tube of the detected object and cancelled out the 180-degree doubt. On board naval ships the orientation of the two crossed loops was bow-stern and starboard-larboard, the true azimuth of the detected radio wave being a derivative of the direction of the boat. An extremely detailed technical analysis with 98 references can be found in the work of A.O. Bauer.<sup>15</sup> These radio direction finders were installed on board Royal Navy ships and also a few units of the U.S. Navy at the beginning of the Second World War.

It is in 1926 that a French engineer appears who is interested in radio direction finding. Born in 1905, Henri Busignies is mad about radio as early as age fourteen. It is during his studies of electronics that he conceives and realizes an automatic radio compass of right-left type designed for aerial navigation. He patents it in 1926<sup>3,20,21</sup> and proposes it in 1928 to a Mr. Deloraine Director of the Parisian Laboratories of ITT, who buys it and hires the young engineer to be part of his research team. In 1929, Busignies perfects another automatic radio compass, utilizing the principles of the Bellini-Tosi system but with a turning probe that works at 600 revolutions per minute. This produced a constant analysis of radio emissions from a 360-degree scan, which was transmitted to a graduated dial, the resolution of doubt of 180 degrees being obtained with an auxiliary antenna.<sup>22</sup> Somewhat later, in 1932, Busignies creates a new radio compass for aerial radio navigation, the RC 5, which used a shielded rotating loop of small dimensions.<sup>23</sup> This

arrangement gives a precision of +/- 2 degrees at a distance of 500 km. In 1938 the French Navy, having learned about the technique of very short emissions used by German submarines, asked the ITT laboratories to try to build a radio direction finder on short waves capable of picking up noncooperative signals of very short duration. The study yielded at the beginning of 1940, an apparatus presenting detection with canceling of doubt on a cathode ray tube with a persisting screen, the deviation of the spot being assured by an assemblage of coils turning in synchronism with the probe.<sup>24</sup> The speed of rotation of the probe (1200 revolutions/minute) allowed, theoretically, the detection of an emission in a twentieth of a second, which was amply sufficient in spite of the ever-decreasing period of emissions of the U-boats obtained towards the end of the conflict by the compression of messages.

At the armistice of 1940, the prototypes were taken apart, the essential parts were spread about in hiding places and the plans hidden away. Shortly after, the American Embassy in France discretely contacted Mr. Deloraine, inviting him to come to the United States with his collaborators to continue their work on short-wave instantaneous radio direction finding. After a rather complicated voyage via Morocco and then Portugal, Deloraine, Busignies, Labin and their families, about eleven people arrived in New York on December 31, 1940 right in the middle of the festivities of New Year's Eve. All of this is told with many details by Kathleen Broome Williams,<sup>3</sup> as well as the difficulties and suspicions (in particular from the FBI for several weeks) involved in trying to establish collaboration between the laboratories of ITT and the scientific services of the U.S. Navy. Eventually, things worked out, and four examples of model DAJ with Adcock antennas for ground stations were rapidly constructed and tested. The excellent results obtained brought about the order for hundreds more, which were deployed from Spitzberg to Brazil and used to watch over the band of 10-200 meters. Then, beginning in 1942, the program of development of instantaneous ship-board radio direction finders got under way. The first model conceived by Busignies, the DAQ, which used fixed crossed loops, was tested in May, 1942 in comparison with the British apparatus.<sup>3</sup> Finally, the results fell out in favor of the Busignies system and thousands were eventually constructed to equip ships of all kinds. It seems that the Huff-Duff model DAQ was at once of higher performance and ease of use, which allowed for more rapid training of the many operators necessary to run them, especially important when considering an operator often could not work more than two hours.<sup>2b</sup>

Other models of Huff-Duff were conceived and built by Henri Busignies, among them mobile stations on vehicles and even a portable.<sup>3</sup> An indefatigable worker of great inspiration Busignies continued to perfect his radio direction finding apparatus, giving rise to numerous patents.<sup>25,26</sup>

Figure 4. (right and below)  
Drawings from the Busignies  
Patent #2,405,800 filed on  
March 13, 1941. A direction  
finder with a filter.

FIG. 1.

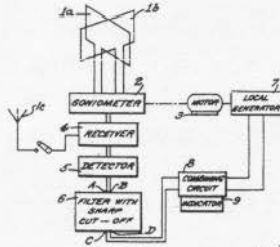


FIG. 5.

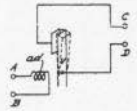


FIG. 7.

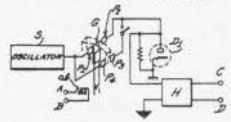


FIG. 6.

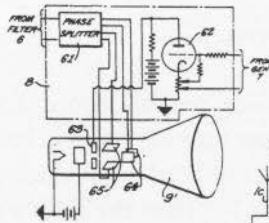


FIG. 8.

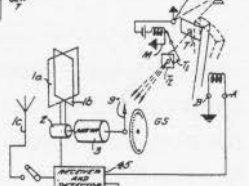


FIG. 2.

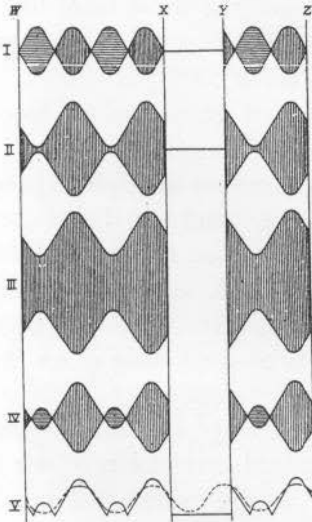


FIG. 3.

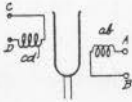
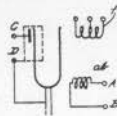


FIG. 4.



INVENTOR  
HENRI G. BUSIGNIES  
BY *E. O. Henney*  
ATTORNEY.



## SOME BUSINGNIE PATENTS

### PATENT #2,406,800 (1941) - DIRECTION FINDER WITH FILTER (Fig. 4)

Summary: Radio direction finder having a pickup member rotating at a constant angular velocity; covering a wide range of frequencies without readjustment of antenna but allowing unidirectional indication, even radio waves that are keyed, modulated or interrupted [burst transmission?].

Fig. 1: Direction finder

Fig. 2: Related curves

Fig. 3, 4, 5: Filters

Fig. 6: One form of combining circuit

Fig. 7: Filter

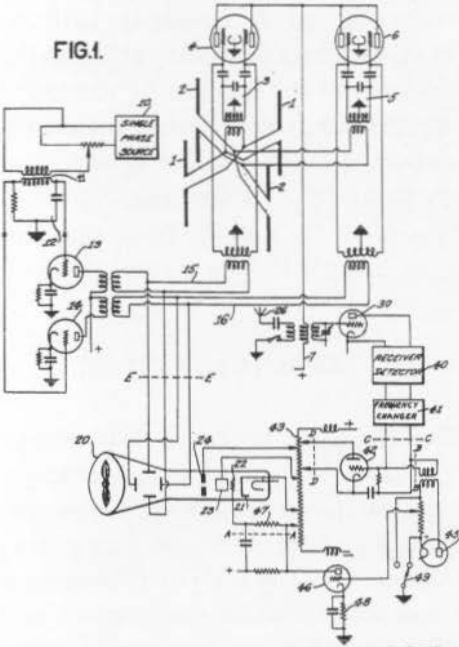
Fig. 8: Modified system

This system uses crossed loops and a collector like a crossed-stator variocoupler. A new feature: using a band-pass filter after detection. Phase splitting and a local generator produce a rotating magnetic field applied to the plates of the CRT. "Thus the indication given on the cathode ray screen has the form of a circle with a radial line extending inward from one point of the circumference thereof toward the center...". Other combining and second phase-splitter circuits produce fields rotating in opposite directions, yielding a stationary oscillating field whose "angle indicates the phase relationship between the wave from generator 1 and the wave from filter 6. Thus under the influence of such oscillating field the cathode ray spot will trace a line indicative of the received radio wave".

Filter: tuned band-pass keyed to the frequency of rotation of the loop, crossed loops or Adcock antennas, for "very great discrimination".

Figure 8 is a visual indicator. A beam of light passes through aligned openings and replaces the electrostatic coupling of Fig. 7 and then illuminates a rotating pointer replacing the CRT. The light is passed through a filter using a vibrating reed, keyed to the signal being read, to illuminate the pointer at useful points during the cycle of vibrations. Persistence of vision means the pointer will appear stationary and a graduated scale gives the reading. An auxiliary shutter cancels the 180-degree doubt.

The full description of this patent is a model of clarity, precision, logical reasoning and elegance. Busignies reveals an extraordinary clarity of mind, a high level of reasoning and great creativity — a truly exceptional mind.



INVENTOR  
HENRI C. BUSIGNIES  
BY *Edw. H. ...*  
ATTORNEY

Figure 5. (left and below)  
Drawings from the Busignies  
Patent #2,408,039 filed on  
March 5, 1941. An electronic  
rotation direction finder.

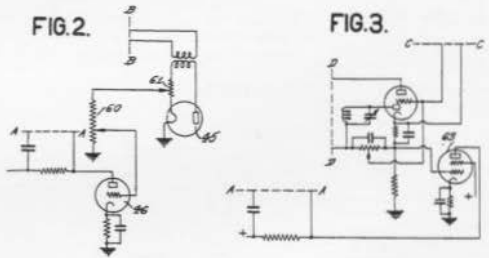


FIG. 4.

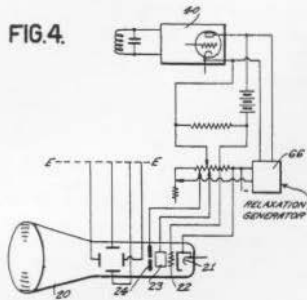


FIG. 5.



FIG. 6.



INVENTOR  
HENRI C. BUSIGNIES  
BY *Edw. H. ...*  
ATTORNEY

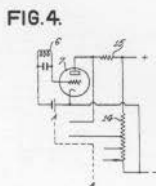
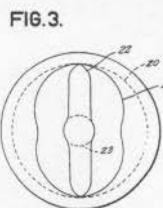
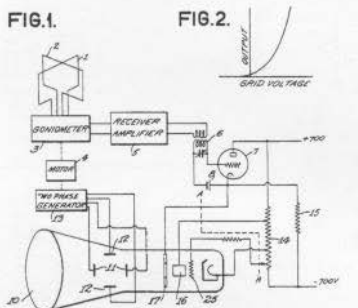
PATENT #2,408,039 (1941) - ELECTRONIC ROTATION DIRECTION FINDER (Fig. 5)

Summary: Goal is to suppress the motor used to rotate the probe coils and to provide the desired rotary effect of the antenna electronically "without the use of mechanical rotating parts;" to synchronise the rotary effect to the rotation of the CRT, and to time the rotation of the antenna to rotate the cathode ray beam. This invention also suppresses the beam when not effective. "...the rotated electron beam will be deflected radially either inwardly or outwardly under control of the envelope potentials." A continuous trace is produced, making a circle, but bias to cut-off is used so the beam operates only under control of the incoming signal. An alternative circuit caused a series of marks to give the indication.

PATENT #2,408,040 (1941) - DISTORTING DIRECTION FINDER RECEIVER (Fig. 6)

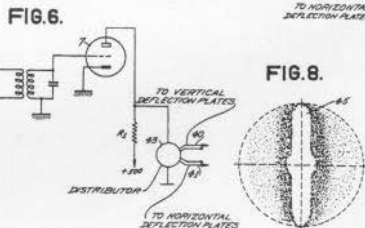
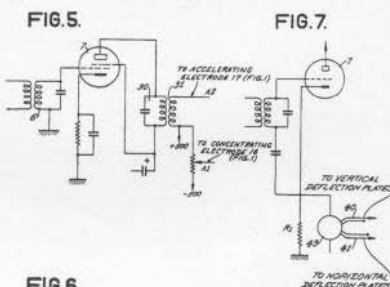
Summary: The envelope used to deflect a cathode ray beam "is improved by the use of a receiver which has a large change in output for small changes in input." The result is much sharper indication on the CRT. The pattern traced in Fig. 3 becomes the inner one instead of the outer one. The goal is to obtain sharper indications through simultaneous rotary and radial movement of the beam. This design aims at two important problems: expensive and maintenance-heavy complexity; and noise created by bearings and rotating parts (addressed elsewhere) that interferes with clear readings.

Sept. 24, 1946. H. G. BUSIGNIES 2,408,040  
DISTORTING DIRECTION FINDER RECEIVER  
Filed March 6, 1941 2 Sheets-Sheet 1



INVENTOR  
HENRI G. BUSIGNIES  
BY *E. J. McManus*  
ATTORNEY

Sept. 24, 1946. H. G. BUSIGNIES 2,408,040  
DISTORTING DIRECTION FINDER RECEIVER  
Filed March 6, 1941 2 Sheets-Sheet 2



INVENTOR  
HENRI G. BUSIGNIES  
BY *E. J. McManus*  
ATTORNEY

Figure 6. Drawings from the Busignies Patent #2,408,040, filed on March 6, 1941. A distorting direction finder receiver.

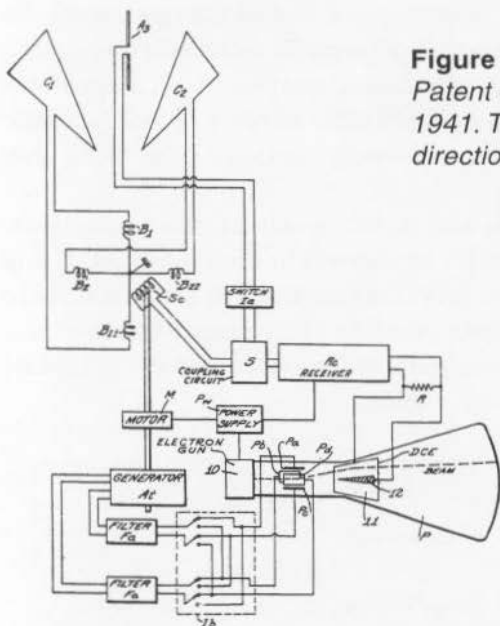


Figure 7. Drawing from the Busignies Patent #24,408,041, filed on May 22, 1941. The instantaneous visual direction finder.

BY

INVENTOR  
HENRI G. BUSIGNIES  
*H. G. Busignies*  
ATTORNEY

PATENT #2,408,041 (1941) - INSTANTANEOUS VISUAL DIRECTION FINDER (Fig. 7)

Summary: Instead of using the frequency of rotation of the receiving antenna, this system uses a "...pair of substantially frusto-conical electrodes to produce the radial deflection," rendering the deflection of the beam independent of the rotation of the antenna.

The standard antenna and pickup coil is used, with a rectifier to produce pulses corresponding to the search coil, fed through a coupling coil, then to an oscillograph "having an electron gun for conventional deflector plates and a special pair of concentric deflector electrodes." A two-phase generator rotates the beam using the deflector plates while the rectified output of the receiver is applied to the conical electrodes "causing a radial deflection of the beam." Thus "indentations or extensions in the circular pattern are produced indicative of the angular rotation of sources of received energy."

Busignies also derived from the preceding inventions a simple apparatus which permitted the transmission of angular or linear coordinates simultaneously on a single HF channel.<sup>26c</sup> (See patent #2,363,941).

PATENT #2,363,941 (1941) - ANGLE INDICATING APPARATUS (Fig. 8)

Through radio, rather than wire, communication, transmitters and receivers in such apparatus can be made safer and more reliable on ship-board by eliminating cables. Using phase displacement and phase quadrature the apparatus can yield "...a summation or differential effect of two or more independently varying angles." A possible adaptation of such apparatus "...is in the fire-control of guns on a ship or other moving vessel. Accurate aim at an objective in spite of the undulatory motion of the firing ship may be assured..."

Advantages: relatively simple and easy to construct, easily adaptable, no inertial effect (no moving parts), can respond to small changes. Using the "search coil of a goniometer ... properly connected to an optical range finder ... could be made to give a direct reading of the range of an objective at some remote location. The various parts of the system can communicate on HF channels rather than through cables.

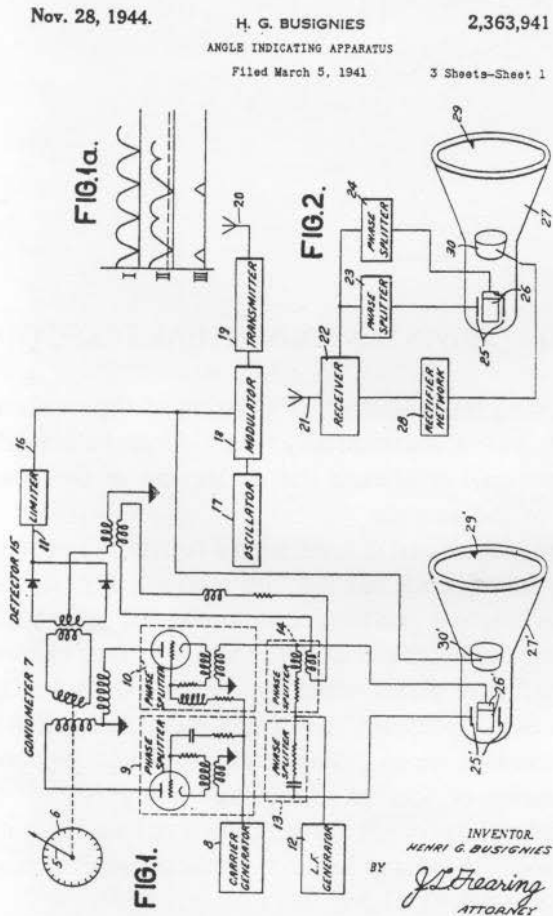
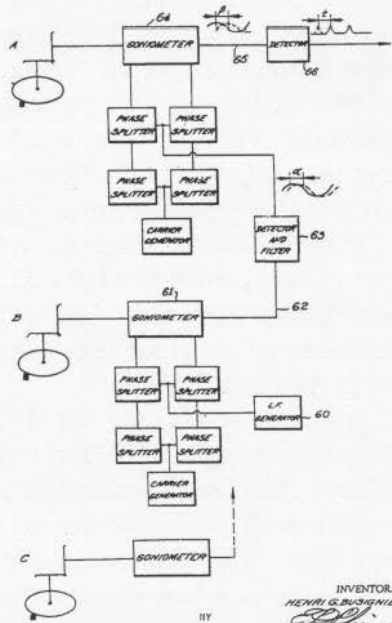


Figure 8. Drawing from the Busignies Patent #2,363,941, filed on March 5, 1941.

Figure 8. (right and below)  
Drawing from the Busignies  
Patent #2,363,941, filed on  
March 5, 1941.

FIGS.



INVENTOR  
HENRI G. BUSIGNIES  
*H. G. Busignies*  
ATTORNEY

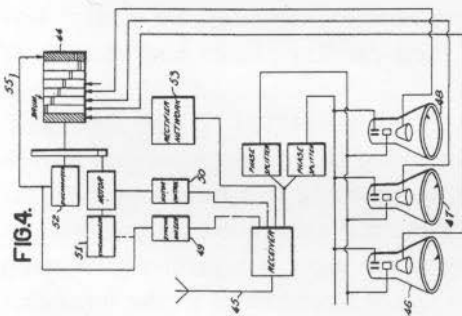
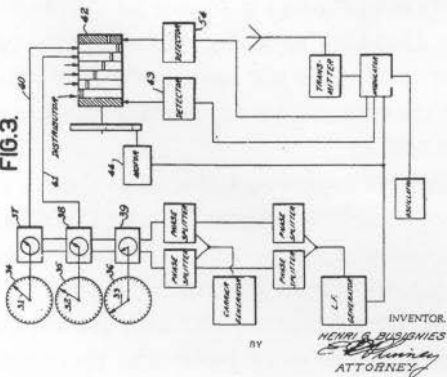


FIG. 4.

FIG. 3.



BY

INVENTOR  
HENRI G. BUSIGNIES  
*H. G. Busignies*  
ATTORNEY

## PATENT #2,379,422 (1942) - GONIOMETER CONSTRUCTION

Summary: Means of reducing reradiated noise generated by make-and-break in bearings and rotating goniometer elements.

Busignies continued working on radio navigation, which led to, among other things, the Navaglobe (long-distance navigation), Navar (air traffic control around airports), Navaglide (instrument and automatic landing), and Navascreen (display and computing traffic control data) systems.<sup>27, 28</sup> The whole of his work is covered by 140 patents. A member of the National Academy of Engineering, Henri Busignies pursued his career in the United States where he became successively President of the Federal Telecommunications Laboratory, Director General, Vice President, and then from 1975 to his death in 1981, Scientific Consultant to ITT.<sup>3, 21</sup> His activities during the war earned him the Certificate of Commendation and the Presidential Certificate of Merit for "exceptional services rendered to the United States and to its allies."

Although it was only one element among many others used in the anti-submarine struggle Huff-Duff made an important contribution to the Allied victory in the Battle of the Atlantic. While it was widely used in the hunt for submersibles, it also served to organize the rerouting of convoys to keep them away from concentrations of U-Boats that it had located. The rapid bearings which sent the Hunter-Killers to a submarine often obliged them to dive, and given their relatively slow submerged speed, they would lose a convoy. In addition, they had the problem of limited time on their batteries, requiring charging before any new attempt could be made.<sup>2b</sup> HF/DF was often used to bring back to their carriers planes lost because of problems in their navigation systems.

Towards the end of the war very much simplified HF/DF apparatus, mounted on board British Mosquitos playing sheep-dog, managed also to bring back to their bases planes that had become lost returning from far away raids.<sup>29</sup> In another area, instantaneous radio direction finding brought a precious aid in the deciphering of Enigma messages. The precise localization of U-Boats was found in the form of coded coordinates in the texts that they would transmit by radio, which brought about a source of "probable words" or "cribs" very useful for the decoding services. Surprisingly, the use of Huff-Duff does not seem to have aroused the suspicions of the U-Boat Navy which continued right up to the very end its regular transmissions, even though they became shorter and shorter.

The German services had nevertheless received numerous photos of allied naval ships equipped with these "strange antennas." Certain of these photos made in Algeiras towards the end of 1943 were touched up before being transmitted to the analysts so no one could determine from where they had been taken, and as it happens the retouching had also erased the HF/DF antennae.<sup>30</sup> Perhaps competing services were protecting their turf.

The German information services had also decoded allied messages stating that navy ships equipped with HF/DF equipment were escorting convoys.<sup>30</sup> However there was one perfectly efficient defense; absolute radio silence. But the absence of reports of activities did not enter into the habits of the German Navy. Moreover, the suppression of radio transmissions coming from submarines was incompatible with the wolf-pack tactic of the units — widely dispersed in the ocean to keep an eye out for allied convoys — which necessarily had to communicate to assemble at the site chosen for the attack.

An analysis of the effectiveness of HF-DF can be found in Broome-Williams. Since it was used in conjunction with radar and Ultra decrypts, the precise role of Huff-Duff is not easy to clarify. It is interesting to note that competent ship-board operators could probably determine approximate distances of contacts by “seat-of-the-pants” experience. Certainly the public image of this important device is one of a sort of black magic, a “sleuth” according to the *New York Times*, that sniffed out U-Boats. Probably because of its secrecy Huff-Duff achieved a reputation of mythical proportions, and the *Times* in 1946 foresaw the detection, using Huff-Duff, of atomic bombs flying toward the U.S.

There is no question that Huff-Duff played a crucial role in the Battle of the Atlantic, and that the machines used were in the majority American, designed by Busignies.

What was it like to operate a Huff-Duff? Kahn<sup>33</sup> gives a description of a British land-based DF station that will have to suffice until further information comes to light: “(The operator) had a cathode-ray tube that scanned the horizon electronically. When it discovered the azimuth at which the signal was strongest a spot in the center of the 9-inch circular tube stretched itself out toward the circumference in both directions. The operator spun the movable glass plate within a metal ring marked in degrees until a wire embedded in the glass lay above the glowing green line. When she put the tube’s cursor on the line, one half disappeared, so that it indicated a single direction — southwest. For example, rather than both northeast and southwest, The work had to be done very quickly, since many of the U-boat signals lasted mere seconds; sometimes the women got the bearing only on the last letter.”

One curiosity worthy of mention is that during the research for this article, the authors talked to many people and advertised widely to try to find either operators of, or portions of, Huff-Duff sets. Only one former operator turned up, now probably deceased, and the trace of only one set ever turned up, possibly the one now in the Smithsonian. Since thousands were made, it seems odd that none has turned up on the surplus market or in the hands of some radio amateur somewhere. Not even a manual has surfaced up to now. Any leads would be welcome.



Since the War, radio direction finding has evolved greatly, the frequencies utilized for transmissions have become greater and the arrival of ferrite cores has simplified the problems of antennas for receiving HF/DF as, for example, the Telegon IV of Telefunken in service in the nineteen-sixties. Those of our colleagues who might be interested in developments in radio direction finding can visit the internet site of the South West Research Institute in San Antonio, Texas, which publishes a group of sixteen thousand resumes of articles from 1895 to 1994 concerning the subject.<sup>31</sup> Also, a bibliography of radio direction finding from 1893 to 1927 has been published by Keen.<sup>32</sup>

### References and Notes

1. MARSHALL, General G.C., King, Admiral E.J. and Arnold, General: *Rapport du Haut Commandement Americain*, Overseas Editions, Inc., New York, a: pp 143 - 281, b: 264 (1945).
2. MACINTYRE, D., a: *The Battle of the Atlantic*, B. T. BATSFORD, London (1961); b: "U-Boat Killer", reprint by Cassell, London (1999).
3. BROOME-WILLIAMS, K, *Secret Weapon*, Naval Institute Press, Annapolis (1996).
4. JOHNSON B. *The Secret War*, BBC Publisher, London, pp 189 -238 (1978).
5. CAVE-BROWN A., *La Guerre Secrete*, Pygmalion/Gerard Watelet ed., Paris (1981).
6. HINSLEY, F. H. and STRIPP, A., editors, *Codebreakers*, Oxford U. Press, Oxford (1994)
7. BEKKER, C., *Radar*, Editions France Empire, Paris (1960).
8. HOWSE, D., *Radar at Sea: The Royal Navy in World War 2*, Naval Institute Press, Annapolis (1943).
9. BELLINI and TOSI, A., *Electrical Engineering*, 2, pp 771-775 (1907); Brit. Pat. 21,299 (1907).
10. BELLINI and TOSI, A., *Ibid*, 3, pp.348-351 (1908); cf. *Electrical World*, pp 1203-1206 (Dec. 21, 1907).
11. Anonymous Editor, *La Nature*, 2361, pp 404-414 (1919).
12. MESNY, R., *Usage des Cadres en Radiogoniometrie*, E. Chiron ed., Paris, pp 114-144 (1925).
13. BEDEAU, F., *Cours Elementaire de Telegraphie et Telephonie sans fil*, Lib. Vuibert ed., pp 435-436 (1937).
14. MONTAGNE. J-C., *Histoire des Moyens de Telecommunications*, ISBN 2-9505255-2-0, pp 376-378 (1995).
15. BAUER, A.O., *Funkspeilung als Allierte Waffe gegen Deutsche U-Boote 1939-1945*, Selbstverlag, ISBN 3-00-002142-6 (1997).

16. WATSON-WATT, R.A., and HERD, J. F, JIEE, 64, pp 611-622 (1926); Brit Pat. 28,971 (1924).
17. ADCOCK, F., Brit. Pat. 130,490, (1919).
18. GETHING, P.J.D. *Radio Direction Finding*, Peter Pelegrinus Ltd., London, pp 2-4 (1978)
19. DE WALDEN, S., ROCKE, A. F. L., BARRETT, J. O. G., and PITTS, B. A., JIEE, 94, pp 823-837 (1947).
20. DELORAINE, M., *Des Ondes et des Hommes*, Flammarion ed., Paris, pp 133-136, 170-181 (1974).
21. VASSEUR, A., *De la TSF a l'Electronique*, Eds. Tech. et Sci. Francaises, Paris, pp 188-197 (1975).
22. BUSIGNIES, H., *L'Onde Electrique*, 9, [105], pp 397-415 (1930).
23. BUSIGNIES, H., *Electrical Communication*, 15, pp 157-172 (Oct 1936).
24. BUSIGNIES, H. et BAC, F., US Pat. 233,966 (8 Oct 1938).
25. BUSIGNES, H., US Pat. 2,208,209 (16 Jul 1940); 2,208,921 (23 Jul 1940); 2,238,211 (15 Apr 1941); 2,243,377 (18 Nov 1941); 2,313,047 (9 Mar 1943); 2,334,247 (16Nov 1943); 2,403,967 (16 Jul 1946).
26. BUSIGNIES, H., US Pat. A: 2,406,800 (3 Sept 1946); b: 2,408,039; c: 2,408,040; d: 2,408,041 (24 Sept 1946); e: 2,363,941 (28 Nov 1944).
27. BUSIGNIES, H., *Electrical Communication* 23, pp42-62 (Mar 1946).
28. BUSIGNIES, H., ADAMS, P.R., and COLIN, R.I., *ibid* 23, pp113-143 (June 1946).
29. HARDIMAN, Captain P., Correspondence with the authors (29 Nov. 1998).
30. ROHWER, J., *Die Funkaufklarung und ihre Rolle in Zweiten Weltkrieg*, Motorbuch, Stuttgart, p. 368 (1979).
31. <http://www.sri.org/3pubs/brochure/d16/shipdff/shipdff.htm>
32. KEEN, R., *Wireless Direction Finding*, Iliffe and Sons, London, pp451-468 (1947)

The authors give grateful thanks to Mr. A. Bauer, Mr. G. Bloch, Mr. E. Codechevre, Mr. A. Douglas, Mr. W. Guion (SWRI) and Mr. J-C. Montagne for furnishing documents and Mr. J-P Buisson for furnishing documents and for computer assistance and Mme. M-C. Moutier, Librarian at the Institut Curie, for searching out publications. Finally, our thanks and our compliments to Mme Busignies for her kind remarks and encouragement.

[Key words: Huff Duff, Instantaneous Radio Direction Finding, Bellini-Tosi, Busignies, Watson-Watt.]

PIERRE DEMERSEMAN, born Aug 10, 1930.

Ph.D. in organic chemistry, University of Paris, 1954. Research director at the French National Center for Scientific Research (CNRS). Today retired. His laboratory, which carries out chemical research on Heterocyclic Chemistry, is part of the Institut Curie in Paris. He is a member of the American Chemical Society. His interest in wireless dates from 1940, when he constructed his first home-made receiver, using 1925 parts. Past-president of the A.E.A., a French association of radio collectors.

He has been a collector of radio sets and books for many years, and of American sets for the past fifteen years. He continues his interest in research, and has many historical radio projects in progress. He and his wife Monique divide their time between Paris and the South of France, and they are also avid travelers in the U.S. which they know better than many Americans. He has published over 200 articles and papers in his career.



RICHARD FOSTER

Born in 1941, M.A. in French at Middlebury, 1970.

Radio and French are intertwined for him, whose interest in both dates from grade school. When his parents gave him the 1938 RCA radio-phono they were getting rid of, he spent a lot of time DXing short waves, and decided to learn French from the obvious beauty of the language. After a twenty-five year career teaching French he decided to convert a hobby business into a full-time affair

of restoring antique radios, which continues today. He now has a collection of between 200 and 300 sets, many of which were obtained during his extensive travels in France. He has written for *Antique Radio Classified*, and for the bulletin of the A.E.A., among others, and this is not his first collaboration with Mr. Demerseman. He and his wife Margaret live in Wayland, Massachusetts and have two daughters. They still have a tiny house in France acquired during teaching days, and try to go there as often as the budget allows.

E-Mail: [richardfoster@prodigy.net](mailto:richardfoster@prodigy.net)

**“ANYTHING YOU CAN THINK OF DOING,  
WE’D JUST DO IT”  
THE EARLY HISTORY OF CHARLOTTE’S  
RADIO STATION WBT**

**Pamela Grundy**

Charlotte, NC

©2000 Pamela Grundy

The early months of 1921 were trying ones for Mrs. Fred Laxton, who lived on at the corner of Mecklenburg and Belvedere Avenues in what was then a newly built neighborhood on the outskirts of Charlotte, North Carolina. The previous fall, her husband and two of his friends had become obsessed with building a device that could transmit “wireless” signals out to potential listeners all across the country. Needing space, Laxton, Frank Bunker and Earle Gluck set up part of their experimental station — which would soon be known as WBT — on the Laxton dining room table. “As I remember,” the Laxtons’ daughter told a reporter some years later, “mother wasn’t very pleased.”<sup>1</sup>

The wires that ran in and out of the Laxton house, connecting the dining table setup with a transmitter in the back yard, placed the three Charlotte experimenters at the forefront of a rapidly developing field. After a quarter-century of using their technology primarily to communicate between individuals, the supporters of wireless communication were beginning to devise an entirely new use for the medium — a use that would eventually be called “broadcasting.” During the 1920s and early 1930s, as signals broadcast from newly founded stations began to work profound changes on American life, WBT would grow into one of the Southeast’s most powerful and influential radio voices. But before reaping the rewards of its founders’ efforts, the station passed through a decade of struggle, improvisation and uncertainty. The spirit with which radio pioneers around the country approached a never-ending array of technical, financial and programming challenges made the 1920s one of the most lively periods in radio history. As a veteran from another early Southern station explained: “Anything you can think of doing, we’d just do it.”<sup>2</sup>

In the fall of 1920, when Laxton, Bunker and Gluck began to talk about building a transmitter, the country was buzzing with the news of Pittsburgh’s KDKA, which had “broadcast” the results of that November’s election to great public fanfare, and which along with other stations was beginning to experiment with other kinds of programming. The publicity

sparked by broadcast excitement drew a wide variety of people into the field. By the end of 1921, thirty broadcast stations had been licensed, and just a year later the number had exploded to 583. That latter number reflected both interest in the medium, and the relative ease with which a station could be started — a license could be obtained from the Department of Commerce virtually upon request.<sup>3</sup>

WBT began in large part as an interesting experiment. Laxton, Bunker and Gluck all had engineering experience and had all experimented with ham radio. Laxton had worked for the General Electric Company, and Bunker was employed by Westinghouse Electric. Gluck, who worked for the Southern Bell Telephone Company, was one of thousands of American soldiers who got their first taste of radio operation while serving in World War I. It so happened that Laxton could lay his hands on two of the vacuum tubes being developed by General Electric in its own broadcast experiments, and after the trio agreed to form a partnership Laxton headed to G.E. headquarters in Schenectady, New York, returning with the tubes packed among the shirts in his suitcase. The men placed the microphone in the dining room and the transmitter out back, and began to fiddle with the transmissions. Gluck, who styled himself the junior partner of the operation, ran back and forth between the transmitter and the house to re-start the record that they were broadcasting (given that the records of the period were short-playing 78s, he probably got a fair amount of exercise).<sup>4</sup>

This first setup was licensed sometime in 1921 as an experimental station, with the call letters 4XD. It had some listeners — a January 1922 article in the *Charlotte News* suggested that a few dozen Charlotte residents enjoyed, in the reporter's words, "dickering with wireless" — although response was low enough that the broadcasters had no qualms about giving out the Laxtons' phone number on the air and asking anyone listening to call. Still, the trio soon developed grander plans. It was becoming clear that radio broadcast was not just a passing fancy. Growing numbers of people were calling to report that they had heard the broadcasts, and ownership of radio receivers was skyrocketing. Herbert Hoover, then Secretary of Commerce, estimated that between the start of 1921 and the start of 1922, the number of radio receivers in the country jumped from 50,000 to 600,000.<sup>5</sup>

Bunker, Laxton and Gluck saw a business opportunity, and in early 1922 they formed the Southern Radio Corporation, to sell radio parts and equipment. The radio station was an integral part of this scheme — a local station, they thought, would help spark interest in their product. They opened up shop in Charlotte's downtown Realty Building, moving their transmitter (in which they claimed to have invested \$10,000) to the building's ninth floor. In March of 1922 they traded in their experimental license for a full-fledged broadcast license, early enough to get three call letters, WBT, before the Department of Commerce ran out of three-letter combinations and started

issuing four-letter ones. On Saturday, March 25, WBT treated a world of potential listeners to a concert of "Victrola music."<sup>6</sup>

WBT's debut was treated with great fanfare by civic leaders, who were delighted both by the near-miraculous nature of radio broadcast, and by Charlotte's participation in the new endeavor. Shortly after WBT's initial broadcasts, the *Charlotte News* rhapsodized to its readers about the technology's potential. "The possibilities which were wrapped up in the locomotive and in the humble telephone ... are all made emphatic in radio transmission," wrote editor Julian Miller. "That means communication not merely within the scope of days or of hours, but instantaneous and so clear-toned as to admit no dissatisfaction. It puts Charlotte and Chicago, for instance, not apart by hundreds of miles, but right alongside of each other. It brings the country to Charlotte and takes Charlotte to the balance of the country with electrical velocity. Radio represents, as a scientific development, all that the intellects of the geniuses of the world and all that the mechanical talent of the years have been able to pour down into the lap of this generation as an agency for swift contact."<sup>7</sup>

Realizing such magnificent possibilities, however, would require a great deal of work. Radio technology was still in its infancy, and keeping a station on the air required constant improvisation, attention and cash investment. The still-experimental technology posed numerous challenges, and demanded continual vigilance. There was also the thorny problem of finding programs to broadcast — one would-be station operator from Burlington, N.C., for example, apparently limited his broadcast ambitions to "Vocal and Instrumental Selections by Local Talent and police reports of stolen automobiles."<sup>8</sup> WBT's early programming showed somewhat more imagination. Soon after broadcast began, station personnel hosted well-known Baptist minister Luther Little, his choir, and as many congregation members as they could pack into their broadcast studio for the state's first religious program. They broadcast plenty of editorial comments, although since most of the speakers belonged to Charlotte's Chamber of Commerce, the opinions were generally limited to accounts of Charlotte's civic virtues. In the fall of 1922, the station created a considerable sensation when Frank Bunker strung a wire over to the city's Wearn Field to broadcast a football game between nearby Davidson College and the University of North Carolina, and as an added attraction placed a receiver and amplifier in the business office window of the *Charlotte News*. According to the paper, "hundreds of people" listened to the amplified broadcast, which "carried the voices, with all their individual intonation, a considerable distance up and down Church street each way, up and down Fourth street each way and into adjoining buildings."<sup>9</sup>

Keeping up a daily broadcast schedule was quite a task, particularly when most early station owners were reluctant to pay their performers. Early program records suggest that in its early months WBT scheduled its

broadcasts at the convenience of its volunteer talent. In October of 1922, for example, the station went on the air one Friday at 10 p.m. to broadcast an opera singer. The following Wednesday, it signed on at 8:30 p.m. for the "Southern Melody Sextette," and then two days later went on at 9:30 p.m. to broadcast "Junia's Hawaiians." (Despite the *Charlotte News*' optimistic suggestion that radio broadcasts were "so clear-toned as to admit no dissatisfaction," a popular opinion at the time was that the Hawaiian music then in fashion was ideal for radio because "it twanged anyway.") Although this inconsistency must have made it difficult for listeners to follow the station, such problems were somewhat relieved by the personal touch of station employee Furman Ferguson, who later recalled that he knew most of the local radio owners, and would phone them up to tell them when the station would be on. As an additional measure, he explained: "I also walked up and down the streets of Charlotte, notifying everybody that WBT would be on the air between the hours of such and such a time."<sup>10</sup>

Finding local citizens willing to perform on the air also involved other complications, since many of the "artists" who were most eager to offer their services had more energy than talent. Longtime WBT employee Charles Crutchfield once recounted the periodic musical ordeal he suffered through while working at WCSE in Charleston, S.C. "The owner of the station was an old sea captain," he explained:

He liked to play the harmonica ... Every time he would come in town he would come to the station and he wanted to play the harmonica ... I'd be playing Guy Lombardo, or Henry King, or Wayne King's music and he'd knock on the glass and motion to the studio microphone. I knew that he wanted to come in and play his harmonica. And he would. That old man would stand there and play terrible music for a half hour, maybe an hour ... This went on week after week after week and ruined my idea of what I thought was a reasonably good program.<sup>11</sup>

WBT's operators ran into a similar situation when they constructed studios at the Andrews Music Company and Efir's Department Store, and Furman Ferguson recalled that "it was sometimes hard to keep the principals of these firms off the air." Station legend claims that such dilemmas were solved by allowing amateur performers to spend as much time as they liked at the microphone, while announcers surreptitiously substituted recorded music after the first tune or two.<sup>12</sup>

Still, the greatest challenge faced by owners of early stations such as WBT involved money. Hundreds of enthusiasts and entrepreneurs had jumped into the radio broadcast field, sensing both excitement and potential profit. While they found no shortage of excitement, profits proved far harder to

come by. Large corporations such as Sears, Roebuck, owner of Chicago's WLS (World's Largest Store), could justify station expenses as useful "good will" advertising. But smaller operations had far more trouble keeping up — it would have taken a lot of radio sales to earn back the \$10,000 that WBT's owners claimed they had spent on the initial station setup, let alone their ongoing expenses. This dilemma was complicated by an early reluctance to sell advertising time — both station owners and federal regulators worried that listeners would be offended if sales pitches were broadcast directly into their living rooms.<sup>13</sup>

Even as station owners struggled to pay bills, expenses mounted. Some of the better-financed stations began to invest in equipment that boosted the power of their signals, threatening to wipe out the broadcasts of those stations that could not afford to keep up. Other industries also began to demand that radio pay them. AT&T claimed patents on broadcast technology, for example, and demanded that broadcast stations purchase equipment and licenses from the company (WBT dropped its power from 500 watts to 250 watts in 1924 to avoid paying license fees at a higher level). When WBT's owners first began to use phone lines to carry remote programs such as the Davidson-Carolina football game back to its transmitter, the local phone company refused to help, because WBT was not using equipment made by Western Electric, an AT&T subsidiary. In the meantime, the American Society of Composers and Performers (ASCAP) was working diligently to obtain copyright fees for music broadcast on the radio.<sup>14</sup>

The combination of growing financial pressures and relatively limited rewards eventually convinced Bunker, Laxton and Gluck that the benefits of running WBT were not worth the trouble, and in 1925 they put the station up for sale. WBT attracted little interest from profit-minded investors. But one Charlotte organization remained firmly convinced of radio's value — the city's Chamber of Commerce. The Chamber's tireless officials, particularly the legendary Clarence "Booster" Kuester, saw WBT as an important component of Charlotte's regional and national image. Chamber of Commerce officials persuaded the local Buick dealer, C.C. Coddington, to buy the station for \$2,000 — far less than the original investment. Earle Gluck stayed with the station, and Bunker and Laxton went their separate ways.<sup>15</sup>

By 1928, WBT remained North Carolina's major broadcaster, as reflected in a successful petition to boost its signal to 5,000 watts, then the maximum station power (there were no other 5,000 watt stations in North or South Carolina). Still, this pre-eminence did not mean the station had solved all its problems. Broadcasts were still limited — in late 1928 WBT was on the air as few as 79 hours a month. And even with such a limited schedule programming apparently left something to be desired. In January of 1928, *Charlotte News* radio columnist Bill Weber defended WBT's use of records on the air, arguing that: "While we all boost our city because we find it a



great place in which to live, we must admit that the local supply of talent for radio broadcasting is limited, indeed." Many of his fellow citizens seem to have agreed with his assessment. When WBT announced its plans to broadcast at 5,000 watts, local radio owners protested that the increased signal would block out programs from more distant cities, and had to be repeatedly assured that it would not create more interference.<sup>16</sup>

The technical complications of the signal upgrade pointed to other ongoing challenges. Although WBT had been operating on the roof of Charles Coddington's downtown headquarters, the new transmitter was installed near Coddington's home out at the edge of town. Two 200-foot windmill towers were erected next to a cotton field — one along the road, and one on a nearby hill. A set of notes from audio supervisor T.G. Callahan's correspondence makes it clear that patience and ingenuity remained important qualities for radio station operators. Callahan noted with glee that the new transmitter building would have "a Kelvinator Refrigerator, Toaster, Percolator and Waffle Iron, as well as steam heat, a shower and electric fans." But while the new transmitter was scheduled to be on line in September, it was not until November 21, after inconveniences that included incorrect blueprints, damage to equipment, a hurricane, and the day when the men installing the antenna on one of the station's new towers "pulled it up too tight and the top 35 feet of the tower ... bent over double," that the transmitter finally went on the air.<sup>17</sup>

T.G. Callahan also recorded one more important event. Two weeks after the new transmitter made its debut, Charles Coddington died suddenly. A year later, WBT was purchased by the Columbia Broadcasting System, one of the nation's fledgling radio "networks." Association with CBS brought a new level of stability to WBT's programming. Instead of going on the air for two or three hours a day, the station was able to broadcast a far fuller schedule, filling much of its airtime with programs that originated in CBS's New York studios. The new owners also sparked a major change in program philosophy. By the late 1920s, radio station owners had learned that the rapidly growing radio audience had few objections to on-air advertising pitches. As advertising quickly grew into the major source of radio income, stations launched greater efforts to fashion programs that appealed to the broad audiences that advertisers sought. In many stations' early years, owners had focused on broadcasting the kind of programming they thought would give the best impression of their communities. Such an approach had generally encouraged not only frequent city-boosting talks, but also a focus on broadcasts of what was called "the better class of music" — the operas, symphonies and other forms of classical music that were seen to give a city an urbane, sophisticated tone. Such broadcasts, however, appealed to a fairly narrow group of listeners. As advertisers clamored for shows that could demonstrate large audiences, supporters of such highbrow entertainment came under greater pressure.<sup>18</sup>

The problems these new circumstances posed for supporters of classical music were evident in a booklet mailed to listeners of Raleigh, N.C.'s WPTF in 1930. The station had clearly been getting many more letters praising broadcasts of "popular" music than those supporting classical programs. (In radio's first decades, before audience ratings were developed, stations judged the size of a program's audience almost exclusively by the number of letters it generated). In a section entitled "Classical Music — And Jazz" the booklet's author came up with a novel way of explaining why the imbalance in the letters did not mean that more people actually preferred dance bands to classical orchestras. "Dance music makes our feet itch, because it appeals to our emotions in an active manner, it is conducive to a motor reaction — singing, dancing, gesturing, talking, or writing," the writer claimed. "The result is that our reaction to radio popular music is to dance a few steps, or sing, or call the station, or write the station .... On the other hand, we are not urged to any such action while listening to classical programs; the result is that we remark to someone who has liked the same classical programs we heard a few nights before, "Yes it was fine; and I've said to so-and-so that we ought to write those people and tell them how fine it was. But we just keep putting it off and never seem to get to it."<sup>19</sup>

While Charles Coddington owned WBT, station managers had been able to resist the drive to build the largest possible audience. Coddington had bought the station as a civic gesture, and he did not insist that it make money — at the end of each year, he simply made up any deficits out of his own pocket. But CBS was in the business to make money. Soon after the station changed hands, WBT employees were instructed to schedule programs that would inspire more letters, and thus pull in more profits. In response, the station turned to a format that would eventually help to spark a wholesale transformation in American popular music. In the North Carolina countryside, and in the textile mills that ringed many state cities, lived some of the world's greatest practitioners of the region's centuries-old string band tradition, masters of a style that would eventually become known as "country music." Musicians such as J.E. and Wade Mainer, Bill and Charlie Monroe, Homer "Pappy" Sherrill, Roy "Whitey" Grant, and Arval Hogan were eager to perform on radio, and Carolina audiences loved them. WBT began to build much of its local programming around these musicians, scheduling locally legendary shows such as the "Crazy Water Crystals Barn Dance," "Carolina Calling," and "Briarhopper Time." During the 1930s, WBT helped make Charlotte into one of the nation's foremost centers for the development, recording and broadcast of the popular style. (Nashville, now the major center of country music recording, would not come to dominate the industry until the 1940s.)<sup>20</sup>

The story of WBT was replicated around the nation, as countless stations started, struggled, and then found success with a combination of network broadcasts and local favorites, all paid for by a growing number of advertising pitches. The meaning of such changes was open to debate — radio's critics decried the "low" tone of some popular programs, as well as incessant advertising spiels, while champions of the new order pointed to the medium's popularity around the country. But the shift that took place in those years would not be reversed. In 1920, radio broadcast was a dream, embodied in a handful of tubes and wires that could be set up on a dining room table. A decade later, it had become big business, and it remains so to this day.

1. *The Charlotte Observer*, April 1957. Thanks to Fred Laxton's granddaughter, Lila Brown, for supplying a copy of this article.
2. Charles Wolfe, *Kentucky Country: Folk and Country Music of Kentucky* (Lexington: University Press of Kentucky, 1982), 40.
3. Wesley Herndon Wallace, "The Development of Broadcasting in North Carolina, 1922-1948," (Ph.D. dissertation, Duke University, 1962), 10-13.
4. Undated newspaper clipping; Wallace, "The Development of Broadcasting in North Carolina," 58-59.
5. *The Charlotte News*, 22 January 1922, 5; Wallace, "The Development of Broadcasting in North Carolina," 19.
6. *Ibid.*, 59-6. Although many early station owners selected call letters that stood for slogans such as "Wonderful Western North Carolina," (WWNC) or "We Believe In Greensboro," (WBIG) WBT had no such significance.
7. *The Charlotte News*, 7 May 1922, 18.
8. Wallace, "The Development of Broadcasting in North Carolina," 80
9. *The Charlotte News*, 19 November 1922, 2-A.
10. Wallace, "The Development of Broadcasting in North Carolina," 71; Furman Ferguson to J.B. Clark, 14 March 1955, WBT archives, Charlotte, N.C. This intermittence was not particularly unusual for radio's early days. At Wilmington's WBBN, owned by two partners in the radio business, the station's schedule was apparently set by customers. Whenever anyone came in to look at a set, one of the partners would slip upstairs, turn on the transmitter, and put on a record, so the customer could see how well the receiver worked. Wallace, "The Development of Broadcasting in North Carolina," 82-83.
11. Charles Crutchfield interview by Lynn Haessly, 8 January 1986, 9-10, in the Southern Historical Collection, Wilson Library, University of North Carolina at Chapel Hill.
12. Ferguson to Clark, 14 March 1955; Loonis McGlohon, "Out There in Radio Land," in D.R. Reynolds, ed., *Charlotte Remembers*, (Charlotte, 1972), 61.
13. For an interesting account of concerns about offending listeners, see Eric Barnouw, *A Tower in Babel: A History of Broadcasting in the United*

*States — Vol. I* (New York: Oxford University Press, 1968), 156-60.

14. Wallace, "The Development of Broadcasting in North Carolina," 64; 87-98.

15. *Ibid.*, 106-109

16. *The Charlotte News*, 15 January 1928, C-11; 22 April 1928, B-10.

17. T.G. Callahan notes, WBT archives.

18. A more detailed description of the relationship between classical music and local booster spirit in Charlotte, see Pamela Grundy, "From *Il Trovatore* to the Crazy Mountaineers: The Rise and Fall of Elevated Culture on WBT-Charlotte, 1922-1930," in *Southern Cultures* 1 (Fall 1994), 51-73. The 1930 census counted 72,059 radio sets in North Carolina, encompassing eleven percent of the state's homes, and almost a quarter of urban homes.

19. "Classical Music — And Jazz," in WPTF publicity folder, 1930, WPTF archives, Raleigh, North Carolina.

20. For further descriptions of hillbilly music on WBT and related stations, see Pamela Grundy, "'We Always Tried to be Good People:' Respectability, Crazy Water Crystals and Hillbilly Music on the Air, 1933-1935," in *Journal of American History* 81 (March 1995) 1591-1620.



Pamela Grundy is an independent historian living in Charlotte, North Carolina, who has been interested in radio history for almost a decade. She wrote a masters' thesis on the early history of WBT, and has published articles on radio in *The Journal of American History*, *Southern Cultures*, and *Tar Heel Junior Historian*. She has also curated an exhibit on Charlotte-area radio history entitled "Don't Touch That Dial: Carolina Radio Since the 1920s," which was on display at the Museum of the New South, Charlotte, N.C., from September 1997 to June 1998.

An earlier version of this piece was delivered as a public lecture at "1998 Spring Meet in the Carolinas," hosted by Carolinas Chapter, Antique Wireless Association, Charlotte, N.C., 21 March 1998.

E-Mail to: [pcgrundy@charlotte.infi.net](mailto:pcgrundy@charlotte.infi.net)

## EARLY RADIO STATIONS: WEEDS AND TREES

George A. Freeman  
Madison, IN  
©2000, RALOGEUM™

The allure and perils of radio in the 1920s are echoed by “new world technology” today. Many companies endowed with an aura of success lack basic business fundamentals. They can wither and die at any time. Many early radio stations, like chickweed, couldn’t make it into the next season. Others may be likened to long-lived trees that continue to flourish and serve us well.

The same question faces the Internet at this writing in the year 2000 that confronted radio. How will the service be paid for? One early answer for radio stations was to have the radio manufacturers and retailers hock their wares on their own owned-and-operated outlets. That’s what this presentation documents.

“Every fifteen minutes all day long, an announcer would say, ‘This is WLW, the Nation’s Station, Crosley Radios and Shelvador Refrigerators, Cincinnati!’ It was a tribute to the tolerance of listeners that the station was never fire bombed.”<sup>1</sup>

As a broadcaster since 1954, I’ve been collecting information about these early radio station owners. For over a decade I’ve been building a list of radio stations whose owners provided the capital, time and energy in the hope their radio stations would sell radios and/or components they manufactured or retailed. I’ve accessed at least 40 sources plus anecdotal hearsay while moving as a gypsy broadcaster from Pennsylvania to Ohio, Connecticut, New York, Michigan, Texas, Indiana and Kentucky.

Large, established firms like G.E. and Westinghouse could weather the research and development investments, rapidly changing technologies, and marketing expenses of early radio manufacturing. They built or bought a string of owned and operated radio stations as marketing tools. Because most of them developed into full power, 50-kW, clear-channel facilities, many of these same radio stations represent healthy, still growing, giant oaks of radio today.



**Figure 1.** *The Doolittle AMPLIFONE.*  
*Source: QST, September 1920, p. 78*

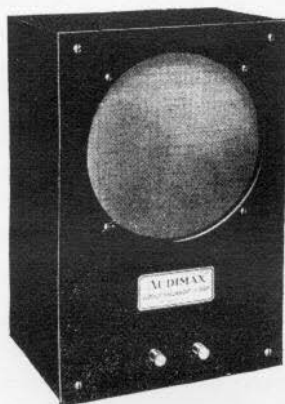
### THE AMPLIFONE

A high grade handsomely finished cabinet loud-speaker which enables you to hear signals all over your station. Even faint signals are readable without head receivers.

**TYPE "A" AMPLIFONE complete. . . . \$15.00**  
 Add postage for 9 lbs. Parcel Post shipment.  
 Send for Bulletin 106 R describing the Amplifone

**F. M. DOOLITTLE CO.**

157 Valley St., New Haven, Conn.



### THE AUDIMAX

The Audimax loud speaker is complete in every respect and will operate satisfactorily with any standard two or three stage audio amplifier.

The Amplifying horn used in the Audimax is so designed as to reduce distortion on voice and music. The Audimax enables you to hear concerts clearly and distinctly all over the house without using head receivers.

The cabinet is solid mahogany, beautifully finished with a genuine hand-rubbed finish. The dimensions are 16" by 11" by 9". Price \$30.00.

Ask your dealer to demonstrate the Audimax.

*Dealers and jobbers write for our immediate delivery proposition.*

**DOOLITTLE RADIO CORPORATION**  
 817 CHAPEL ST., NEW HAVEN, CONN.

**Figure 2.** *The Doolittle AUDIMAX.*  
*Source: QST, July 1922, p. 86*

“Now the Westinghouse people do not pretend to be philanthropists. Their broadcasting service is business and they admit it. They manufacture radio sets. They want a market for those radio sets. To create a market they must make the sets valuable to purchasers. Hence the broadcasting. Hence, too, the excellence of the broadcasted programmes, for the better the entertainment the larger the audience.”<sup>2</sup>

WFAN-AM, New York City, America's top billing radio station in 1999,<sup>3</sup> originally was WEAJ, the AT&T owned and operated station. It was taken over by RCA in 1925.<sup>4</sup>

Those taking the largest risk were small radio manufacturers and marketers. They too had costs of R & D, manufacturing and marketing, plus the costs of operating and staffing the radio stations. Stories of the smaller manufacturers and marketers could become high drama. Let's begin with two towns with almost identical population size in 1920:

#### **TOWN #1**

(The author gathered the following information as a result of having been employed as a broadcaster in Hartford, Connecticut. )

This is the tale of a radio inventor, radio manufacturer and broadcaster:

The Yale/Princeton football game on November 12, 1921 brought forth the entrepreneur who would put Connecticut's first amateur radio station, Connecticut's first commercial radio station, and America's first commercial FM station on the air. His first initials were F.M., and FM would be one of the places where he would make a national mark.

Franklin Malcom Doolittle built the transmitter that would be used to cover the Eli game and feed play-by-play information to wireless operators, which they would relay to newspapers.

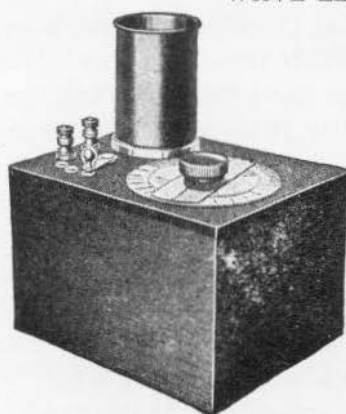
By February, 1922 Doolittle had 1AGI on the air from his New Haven, Connecticut home. In December of that year Doolittle's WPAJ signed on at 360 meters (833 kc). The radio station shared a storefront by 1923 on New Haven's Chapel Street at which one could shop for Doolittle Amplifone speakers, (Fig. 1 and Fig. 2), Doolittle Decremeters (an amateur transmitter tuning device...Fig. 3) and later, Doolittle radio sets. Doolittle radios were pricey. They sold for from \$250.00 to \$300.00, but "Demand was always equal to supply."<sup>5</sup>

Franklin Doolittle invented stereo broadcasting, calling it Binaural Broadcasting. On August 16, 1924 the Federal Radio Commission opened a three-month window for a non-renewable authorization, permitting Doolittle to experiment with two-channel broadcasting. Two transmitters were used;

THE

# Doolittle Decremeter

WAVE LENGTH DECREMENT



(PATENT APPLIED FOR)

The Wavemeter is the Yard Stick of the Radio Art. In tuning up a Spark or C.W. set, and in countless laboratory experiments it is the ultimate source of reference. But the Wavemeter does not tell the whole story because it does not measure the Logarithmic Decrement, the factor which tells whether the energy radiated by your set is concentrated in a single sharp wave of great intensity or spread over a broad band of wave-lengths where it causes QRM and reduces your range.

The Doolittle Decremeter is both a superior Wavemeter and a Decremeter. The Wave-Length and Decrement can be obtained simultaneously, without complicated calculations. The range is 130-300 meters. An ideal instrument for radio Clubs as well as individuals. Immediate delivery can be made.

Price - - \$25.00

SEND FOR BULLETIN 107R  
DESCRIBING THIS INSTRUMENT

**F. M. DOOLITTLE CO.**  
817 Chapel Street, New Haven, Conn.

**Figure 3.** *The Doolittle DECREMENTER.*

*Source: QST, April 1921, p. 98*

the regular WPAJ at 268 meters (1120 kc), and the second at 227 meters (1320 kc). Patent #1,513,973 was issued to Franklin M. Doolittle for stereo broadcasting technology. A second stereo-related patent, #1,817,177, was granted to Mr. Doolittle for a stereo sound-recording apparatus. Both these patents were sold to RCA. Why RCA? A look at Doolittle's biography might help explain.

Franklin M. Doolittle was born in 1894. His first creation was a coherer receiver, using technology that preceded the crystal set. At age 15, in 1909, young Doolittle got a job for United Wireless Telegraph Company taking messages from vessels on Long Island Sound. During high school, and college at Yale University, Doolittle worked summers aboard ships as a radio operator for Marconi Wireless. With shared job functions and employer, Doolittle and RCA's David Sarnoff became kindred spirits. Doolittle and Major Howard Armstrong both would sell patents to RCA in the 1920s. Upon graduation Doolittle went to work for the Bell Telephone Company. Then came World War I. Doolittle was commissioned and served as communications aide to Admiral Hoogerwerff, commander of the Fourth Battleship Squadron in the Atlantic.

The year 1919 saw the return of peace and Doolittle's return to New Haven, where he became a part-time instructor in the Electrical Engineering Department at Yale. There he worked through 1926. During this period F.



M. Doolittle showed his entrepreneurial side, setting up a shop building radios, amateur speakers, and transmitter monitoring equipment on the third floor of 917 Chapel Street.<sup>8</sup>

By the spring of 1925 the station call letters were changed to WDRC (Doolittle Radio Corporation). It would become one of 16 charter members of the National Broadcasting Company chain, participating in the inaugural broadcast on the evening of November 15, 1926 from New York's Waldorf Astoria Hotel. There were power increases and a time-share arrangement with WCAC, Storrs, CT in the late 20s. By 1930 WDRC had become a CBS affiliate for the Hartford/New Haven/Springfield, Massachusetts region. Studios were moved to Hartford, and by 1935 the station reached its final daytime power of 5 kW. Equal nighttime power would come later.

Now for the Doolittle FM story. Doolittle's W1XPW, a "High Frequency Broadcast Station" signed on in May, 1939. On February 14, 1941 W1XPW participated in the first FM network tests with Major Armstrong from his station at Alpine, New Jersey.<sup>9</sup> The station would become W65H in the pre-war band at 46,500 kc, with a service area of 6,100 square miles. In 1946 the call became WDRC-FM in the post-war FM band.

During the 1950s Doolittle acquired a site for a proposed television station, but the plans did not bear fruit. WDRC-FM, rather than attempting to originate programming, took a much less expensive direction; they simulcast other stations. One of them was WCBS-FM in New York city. For purposes of this discussion we must point out the heritage of WCBS-FM.

The call letters WCBS-FM are an extension of the flagship AM Columbia Broadcasting station, WCBS. That station was originally WAHG, the initials of radio manufacturing pioneer Alfred H. Grebe. In 1926 WAHG listeners heard songs by the Grebe Matinee Trio at 12:03 pm on Sundays. The same evening, probably the same singers became The Synchronphase Trio at 7:30.<sup>10</sup> The accompanying list of radio manufacturer-linked stations documents several radio stations owned and operated by Grebe. He would broadcast yacht races from his portable station WGMU to the first marine broadcast station, WRMU. Like Franklin M. Doolittle, Alfred H. Grebe also had served on the high seas as "Sparks" (radio operator) from 1911—1914. It was during trips to the Orient that he became enamored of his perceived lifestyle of the Far East. This was manifest in his use of the Dr. Mu character in advertising for Grebe radio sets in the 1920s (Figure 4). Grebe began manufacturing radio sets for the U.S. Navy in 1917 for use on submarine chasers. Their dials were radium coated for visibility when sailing without lights.<sup>11</sup> Years later Al Grebe was sued by newcomers to the radio manufacturing art, RCA, then Westinghouse, for allegedly infringing their patents.<sup>12</sup> After Al Grebe's sudden death in 1935, the legacy of his WAHG as a powerful competitor to RCA's WNBC and Westinghouse WINS, New York City stations seems fitting retribution. Most vintage radio hobbyists feel their collection



**Figure 4.** Grebe's Dr. Mu.  
 Photo: Source: QST,  
 October 1922. p. 4.

is not complete without at least one Grebe radio in their collection. Often it's one of the Synchronphase models.

By 1952 WDRC-FM was simulcasting a different station, WQXR-FM, also in New York City. These calls repeated those of the senior sister station, WQXR-AM, and they were as close as its 1936 originators could get to their original ham calls, W2XR. One of the founders was a fellow Yale graduate and radio engineer. His name was John Vincent Lawless Hogan. He too had contributed "...inventions to the broadcast art, the best known being the 'single dial control' which made it unnecessary for the listener to twiddle three or four knobs on his set in order to tune in a program."<sup>13</sup>

The author, working in 1958 as radio news director at contemporary programmed radio station WNHC, New Haven, CT took pleasure on occasional weekends listening to WQXR beaming classical music across Long Island Sound to his home at Short Beach, Branford, CT.

The present WDRC-FM call letters were assigned in 1958 to a new station created by Doolittle as he prepared to sell out. Buckley-Jaeger

Broadcasting purchased both the new WDRC-FM and WDRC-AM for \$815,000 in 1959. Prior to this sale, in the 50s Mr. Doolittle had sold all but a small interest in his original WDRC-FM. The new owners re-named the station WHCN for their Concert Network of stations. The WHCN calls were still with Connecticut's first FM station, pending a sale nearly 50 years later.

The author joined Buckley-Jaeger's staff as news director at WDRC AM/FM in 1959, four months after their take-over. My number-two man was Mike Stein who went on to become the news director of WNEW AM, New York City. He wrote the scripts read by Harry Reasoner, and later Peter Jennings on the ABC (TV) Evening News. My number-three man was Bud Steele. He became known as Harold Steele, the morning newsman for many years at WMAL, Washington, DC. He also worked part time for years at Voice of America.

Our principle competition was 50,000 watt WTIC, at 1080 kc. It was a consensus among the staff that Doolittle had failed to keep his AM station competitive with both dial position and power upgrades. Our 1360 kc and 5,000 watts day/night signal could not provide the loudness so necessary to be the top station in the market, but nevertheless the WDRC Stations have continued to be very competitive. The stations forced out CBS after 38 years and switched to rock-n-roll programming, enjoying the successes of the top-40 format all across America.

A continuing cadre of former WDRC employees from our rock-n-roll era stays in touch today. We e-mail each other and occasionally have reunions. A former on-air alumnus who wrote the history of all the radio and TV stations in New Hampshire<sup>14</sup> is Ed Brouder. As "The Man from Mars," Ed has put together his own website as a celebration of WDRC, complete with the original jingles.<sup>15</sup>

While the growth of his radio stations was stunted, Franklin M. Doolittle had made substantial contributions to broadcasting in conceiving the beauty of stereo and helping to introduce the superior technology of FM.

## TOWN #2

(The author assembled the following information as a result of broadcasting experiences in the New Castle, Pennsylvania/Youngstown, Ohio area.)

In the late 1990s the author phoned the historical society at Youngstown, Ohio. "Do you have any artifacts from Youngstown's first radio station, WMC or its owner, Columbia Radio?" There was a moment of silence, then a measured response, "Youngstown's first station was WKBN."

Youngstown's first two radio stations have virtually disappeared.

In the minds of the average Youngstowner their first radio station was WKBN, licensee of which was Radio Electric Service Company. Creed M.

Chorpenning, 8WR, later W4TZ, of Astatic microphone fame and Warren P. Williamson, Jr. were early WKBN ramrods. WKBN was Youngstown's third radio station.

This is the story of Youngstown's virtually unknown first radio station. Were it not for the 30-year old masters thesis of Steve Grcevich, this story could not be told.<sup>16</sup>

In western Pennsylvania, a dentist's son, young Wayne Shaffer, 8GW, got his radio manufacturing experience in New Castle working for Rex L. Patch, 8HA, at Pennsylvania Wireless Mfg. Co.<sup>17</sup> Patch had been experimenting with radio since 1910, turning out his first complete radio sets, a one-tube design, around 1919.

Moving a dozen miles west to Youngstown, Ohio, Shaffer commenced providing radio components and assembling radios as Columbia Radio Company in 1921. Youngstown was an important steel town (18), much larger than New Castle. It was here, amid the gritty bustle, that Wayne Shaffer would plant his seed as station 8GW, which began voice transmissions on January 24, 1922. The Youngstown Vindicator carried the following notice on that day at the beginning of its classified ad section:

### **COLUMBIA RADIO CONCERT PROGRAM FOR THIS EVENING**

A Brunswick Radio concert is scheduled for tonight by the Columbia Radio Co. The concert which is under the auspices of The Schuman Furniture Co. will start at 9 pm.

The Columbia Radio Co. broadcasting station's call is 8GW operating on a 250-meter wave length.

The Brunswick reference means that the program was composed of phonograph records played before a carbon microphone in the makeshift studio at Wayne Shaffer's home on West Midlothian Boulevard. Station 8GW provided regular programming from 8:30 to 9:45 each evening.

Shaffer's first newspaper ad for the radio shop appeared on Sunday, March 3, 1922. That same month, on the 27th, the call letters WMC were assigned by the Commerce Department to Columbia Radio Company. Wayne Shaffer now possessed one of the four radio station licenses for the entire state of Ohio.<sup>19</sup> On April 10th Wayne began writing a column for the Youngstown Vindicator (entitled "The Vindicator Radio"). Now it appeared that Shaffer had all the synergies for his enterprises. He had his own radio retail store and repair shop, Columbia Radio,<sup>20</sup> which could convert customers to listeners of his own radio station, WMC. The radio station would promote Columbia Radio, and he had his newspaper column to promote both WMC and Columbia Radio set sales and service (Fig. 5).

**COLUMBIA RADIO COMPANY**

CONSULTING  
DESIGNING  
CONSTRUCTING

**RADIO  
ENGINEERS**

"IN RADIO  
SINCE 1916"



**COLUMBIA PRODUCTS**

**COLUMBIA - RADIO - CO.**

South Ave. at India      Youngstown, Ohio

SUPPLIES  
PARTS  
COMPLETE SETS  
RADIO & AUDIO  
FREQUENCY

"EVERYTHING  
IN RADIO"

**Figure 5.** *Columbia Radio Co. advertising blotter.*  
*Credit: Steve Grcevich*

Youngstown's chamber of commerce in 1922 knew the community had a problem. It was a one-industry town. A team spent ten days visiting successful cities to learn how to attract new industry. The standout: Memphis, Tennessee. From 1919 through 1922, 338 new industries had moved or started up in Memphis. In May, newspapers announced the end of a search for a person who would head Youngstown's New Industries Committee. He was Mark Fenton of Memphis, TN, the man in the middle of all that success.

For Wayne Shaffer, his bed of roses was thorns, not flowers. Ten days after assignment of the WMC call letters he learned the big music store in downtown Youngstown was granted call letters for a new radio station. Yahrting-Rayner Piano Company would open a radio department which would be promoted by its station, WAAY. Radio WAAY signed on using a top of the line Western Electric transmitter, in contrast to Shaffer's homebrew transmitter. On April 22, 1922 the competing newspaper, The Youngstown Telegram, sponsored a radio party.

Like the Internet entrepreneurs of today, Shaffer worked long hours, seven days a week. He fell behind on his newspaper column. His information came to the newspaper in the form of one long, technical article rambling with no paragraphs, stops or starts, and no accompanying explanation for lay readers. The Vindicator, clearly miffed, deleted Shaffer's by-line by April 27, 1922.

"Throughout the summer and autumn of 1922, Shaffer continued to devote himself to the difficult task of successfully operating a full-time radio business ... and at the same time attempting to continue his nightly broadcast service."

His WMC investment in time and money was constantly growing. How much that investment was probably will never be known, as there appear to be no financial records covering the period when Shaffer constructed his equipment and maintained his transmissions. Shaffer claims that, to the best of his recollection, the cost in equipment alone involved several thousand dollars.

The lack of direct revenue from the operation of WMC forced Shaffer not to request an extension of the station's license in December, and on December 19, 1922 the Department of Commerce deleted WMC from its list of authorized stations."<sup>16</sup> Thirty-three days later, on January 21, 1923 the call letters WMC were assigned to Memphis, Tennessee. The heritage call letters were subsequently assigned also to a Memphis FM radio station with 300kW (Note: 300 kW is correct), the tallest of oaks. A VHF television station was assigned to Memphis as WMC-TV. This is VHF channel 5 in an intermixed market. That means UHF TV stations had to compete with VHF stations in the same marketplace. VHF stations in these circumstances billed millions of dollars effortlessly because of their overwhelmingly superior technical facilities and much larger coverage patterns. (Cable systems have somewhat evened the playing field for UHF since those days.)

Youngstown became part of the rust belt when steel died in Youngstown in the late 1970s. Memphis, in addition to attracting those 338 new industries, got the heritage three-letter call sign which Youngstown failed to nurture.

That's one example of how perilous could be the life of a hardscrabble seedling radio station in 1923. Like chickweed, it would not see a second year.

## RADIO WKRC

(The following information was researched while the author operated WIKI-FM licensed to Carrollton, KY with main office and studios in Madison, IN.)

Diagonally across Ohio, in the southwest corner of the state, we have Cincinnati and the story of Leo J. Ainsworth. In 1920 Cincinnati was three times the size of either Hartford or Youngstown. Ainsworth, an accountant for a northern Kentucky steel company, uncovered a large overpayment of federal income taxes by his employer, traveled to Washington, DC and got the money back! His employer gratefully gave Leo a substantial bonus from the proceeds, and it was this money that the young bookkeeper used to buy a radio retail store in downtown Cincinnati.

The store had a radio department, complete with service man Howard Gates, 8BVB. Howard manufactured a few radios called the H. A. Gates model 2-1-2 around 1923. The two men got along well at first, and hatched plans to manufacture radios. To make these radios sell, they applied for



making and selling the "Homcharger" battery chargers, and by 1924 Ogden was ready to manufacture radios. He would be another competitor to Crosley (Fig. 8), Leo Ainsworth's kind of guy. Ogden envisaged a one-tube radio about the size of a camera and he wanted his radio manufacturing company to be the Kodak of radio. So he chose a name as close as he could to George Eastman's Kodak, and changed the end of the word to honor his wife, Della; thus Kodel.<sup>22</sup> Ainsworth sold WMH to Ogden and it became, overnight, WKRC (Kodel Radio Corporation) (Fig. 9). Kodel put higher towers on the Alms; the 125' Towers, plus the 275' height of the Alms Hotel, totaled 400', the highest antenna in Cincinnati.

WKRC has had many owners, usually an unhealthy sign for a station. Among them, CBS, the Gruen Watch Company and Ohio's Taft family. The WLW owner, Jacor, who owned the station briefly, changed the call letters to WLWA. (Leo Ainsworth must have turned over in his grave.) Then Jacor changed the calls back again to WKRC. WKRC is one of 870 radio stations and WKRC-TV is one of 19 television stations, owned, operated, or controlled at this writing by Clear Channel Communications.

Here's a working list of these early stations put on the air to sell radios. Take a look at who these daredevils were. You'll probably recognize manufacturers' names from your own collection. I guarantee you'll be surprised by some of the names who took the plunge into radio station ownership. I'll appreciate your input as we continue building this list. As you scan stations you're familiar with, feel free to rate them with a \* if they turned out to be annuals, or a ! if they turned out to be perennials.

## "ACE RADIO CONCERT RECEPTOR"

**A**  
**ACE**  
**E**



**A**  
**ACE**  
**E**

Licensed under Armstrong Patent 1,113,149

**Type TRU Concert Receptor - - - - - \$50.00**

This unit is especially designed for the efficient reception of Radio Telephone Concerts from even the most distant Broadcasting Stations. The ease with which this Receptor can be installed and the extreme simplicity of operation make it ideal for use by even the most inexperienced. No previous knowledge of radio necessary to secure results.

We stock a complete line of Radio Supplies and maintain a prompt, reliable Mail Order Service that reaches all over the world.

Send 5c in stamps for catalog to Dept. "C"

### THE PRECISION EQUIPMENT CO., Inc.

Manufacturers, Distributors and Retailers of Radio Apparatus  
PEEBLES CORNER, CINCINNATI, OHIO

Cable Address "ACE, Cincinnati." Radio 8XB, WMH

**Figure 7. Radio Station WMH.**  
Source: Wireless Age, April 1922, p. 60



# CROSLEY



HARKO SENIOR NO. V



2 STEP AMPLIFIER

### Crosley Harko Senior V Receiver

The Crosley Harko Senior Receiver No. V. has been greatly refined as to detail, hook-up, etc., and is a remarkably efficient tuner and detector unit capable of bringing in concerts and signals from surprising distances. It is non-regenerative, which means easy to tune without distortion. Manufactured in large quantities in our own factories makes the low price possible. Cabinet work, Adam brown mahogany finish. Newest refinements in design of panel fittings, including molded knobs and dial. Price.....\$20.

### Crosley 2 Step Amplifier

The Crosley 2 step Amplifier. A most efficient piece of apparatus especially when hooked up with the Harko Senior V., but giving excellent results with any audion receiving set. Contains two celebrated Crosley V. T. Sockets, Crosley Rheostats and Crosley Sheltrons (new design transformers), Cabinet matches Harko Senior V. in wood and size. Niceties of design and finish are the same in both instruments.



Figure 8. The bottom logo of this July 1922 QST ad clearly documents the relationship between radio set sales and the Crosley radio station WLW.

Figure 9. Radio station WKRC. Source: Radio News, December 1925, p. 760

## KODEL RADIO

The Emblem of  Worth in Radio

### To Own It, is to Own the Best



**LOGODYNE** \$90.00  
"BIG FIVE"

Five tubes, self-balanced tuned radio frequency, sliding panel and staggered, fractional variable, Adams brush mechanism output; condensers for battery storage; extremely rugged for long service.

The LOGODYNE Big Five well deserves to bear the name KODEL RADIO. For no receiver could better express or exemplify, or better prove in actual performance, the high standards of quality to which the KODEL RADIO line is built.

In range and power a master; in tone as true and mellow as an old Stradivarius; in appearance a masterpiece of the cabinet maker's art; the LOGODYNE Big Five matches in every respect the perfection that is required of KODEL RADIO receivers—the best that radio offers.

*Free* Send for the new edition of our free booklet "The Care of Distortion and Volume in Radio". Gives helpful interesting information on radio operation.

**THE KODEL RADIO CORPORATION**  
591 East Pearl Street Cincinnati, Ohio

**WKRC**  
Owners of Kodel Broadcasting Station WKRC on the Aloha Band. Best for program.



LOGODYNE "Big Blue" Complete "High-Boy" Receiver of Radio. Built-in loud speaker, same mechanism for battery and storage. Minimum price on furniture design. \$275



LOGODYNE "Model Blue" Complete down market on well-balanced receiver components for A and B sets. Same mechanism for battery and storage. \$165



LOGODYNE "Model Blue" Complete down market on well-balanced receiver components for A and B sets. Same mechanism for battery and storage. \$70



LOGODYNE "Model Blue" Complete down market on well-balanced receiver components for A and B sets. Same mechanism for battery and storage. \$30

The Yale "Gold Star" Model... \$20

The Yale "Gold Star" Model... \$12

The Yale "Gold Star" Model... \$6



## The New Sweeney Radio-Phone

Retriggering the demand for a set to receive the radio-phones broadcasting of entertainment features as well as market reports and government information, our engineers have developed this receiver which incorporates simplicity of operation with its ability to receive long distance stations with clearness and sufficient volume to operate a loud speaking horn. The wave length range will cover those being used for the broadcasting of musical programs as well as the government live stock markets, grain quotations and weather forecasts. All sets are carefully constructed with the best quality of material and most Radio frequency amplification, one of the newest developments in radio reception, is used, which accounts for the extreme sensitivity of the instrument and enables the operator to pick up long distance stations. The audio frequency amplification increases the signal strength to such a volume that any type of loud speaking horn at present on the market may be operated. Write for special low introductory price.

### Specifications Sweeney Radio-Phone

**Color:** Genuine solid walnut, hand rubbed.  
**Cabinet:** Floating circuit consists of an antenna coil with four turns and a series variable condenser with length from 1 1/2 to 6 1/2 inches. Two Radio frequency, detector and two audio frequency amplifiers.  
**Price:** \$49.95. \$315 inch thick Walnut Kabinet. Smooth finishing and easily adjusted. Only two adjustments required in tuning.  
**Features:** are in rear of the cabinet in which the aerial ground, A battery and B battery are contained. Wiring and connections substantially made with 1/16 inch brass rod with ceramic tube covering.

### SWEENEY BROADCASTING W. H. B.

**This Is One of the Largest Inland Stations in the Country**

and sends out official Government market and weather reports every day, besides giving musical, educational and religious programs on Sundays, Tuesdays and Thursdays. Through the courtesy of C. G. Conn & Co., Elkhart, Ind., Makers of Musical Instruments, we are broadcasting some of their concertos.

This station cost \$50,000 to erect. CALL 15—WHB—360 meters for concerts and 485 for Government reports. 500 watts P. E. set provides its power. This great broadcasting station is evidence of the capacity of the Sweeney Company to serve you in the purchase of all supplies and equipment.

### Get This Radio Catalog and Instruction Book

Every radio enthusiast should have a copy of this valuable book which is a mine of the proper and descriptions interesting matter and descriptions and lists that will save you time and money. Including, booklets showing high frequency amplification operation and how you may better yourself. Do not buy any radio supplies until you have seen this book as we have given this business on a great scale and we required to supply you with the best and we have prepared new material in these prices. This book has been prepared by some of the best known electrical and radio engineers and is a practical instruction. Look up dealer or manufacturer near in charge. Get your copy today.

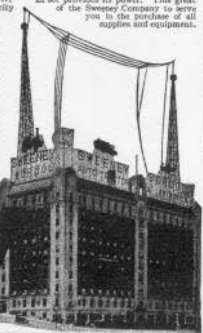


Figure 10. (above) An illustration of how experimental the revenues question was at the time. "WHB invited listeners to send money for imaginary seats in an 'invisible theatre' of radio. Ten dollars entitled the contributor to a box seat, five dollars to a balcony seat, and one dollar to a gallery seat — all equally mythical, but bringing in some three thousand dollars." Source: Radio News, November 1922, p. 826.

# IDEAL

## FILTER CONDENSER

Type ICC

The Ideal Condensers have met with great favor in radio circles throughout the country, all because of their super-efficiency.

Recently designed to stand potentials of 2000 Volts without puncturing, and at no increase in price.

These attractively priced condensers may be obtained from any of the dealers listed below. They will furnish you with complete information regarding the IDEAL LINE.

1 Mfd 2000 Volt Condenser . . . \$2.00	
2 Mfd 500 Volt Condenser . . . 1.50	

Somerville Radio Lab.,	Boston, Mass.
Benwood Company, Inc.,	St. Louis, Mo.
Pitt. Radio & Appl. Co.,	Pitts., Pa.
Hemple Electric Co.,	Omaha, Nebr.
Klaus Radio Co.,	Eureka, Ill.
Standard Radio Co.,	Los Angeles, Calif.
Nola Radio Co.,	New Orleans, La.
John R. Koch,	Charleston, W. Va.
Cino Radio Mfg. Co.,	Cincinnati, O.
T & H Radio Company,	Anthony, Kansas
Wireless Mfg. Co.,	Canton, Ohio
Northern Radio Co.,	Seattle, Wash.

C-W CATALOG FREE  
**IDEAL APPARATUS COMPANY**  
 EVANSVILLE,  
 "9XAH" INDIANA "9XAH"

Figure 11. (right) This April 1922 QST ad preceded 9XAH becoming WNAM, licensed to Evansville, IN in 1923.

# This is station K.S.&S.Co.

Figure 12. (right) Kellogg Switchboard & Supply Co., CHICAGO. Many companies that chose not to dip their toes into the dangerous waters of radio station ownership nevertheless felt compelled to look as though they did. Here's an example of what we now call a Virtual Radio Station, KS&S. It existed solely on paper.

(Source: Radio News, Nov. 1922, p. 931)

**ANNOUNCING**

**Better Radio Equipment**  
Kellogg Built Throughout

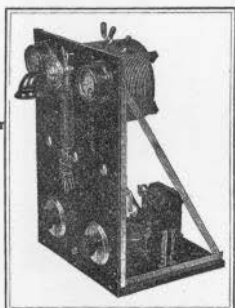
No. 60A Head Set, \$12.00  
No. 21 Microphone, \$7.50  
No. 3 Tube Socket, 75c  
No. 201 Dial  
No. 808 Variable Condenser  
No. 201 Variable  
Grid Condenser, T22 with No. 201 W.C., 13c, complete, \$1.25  
Air Choke Coil, \$1.25  
No. 201 Four Conductor Jack, \$1.10  
Grid Leak, 10c and Condenser, 25c with No. 201 Plug, \$1.10 complete, \$1.35  
Four Core Choke Coil, \$1.00  
No. 201 Plug, \$1.25  
Set of 201 Condenser Plug Clips, 50c

No. 4 Standard 1500

**KELLOGG STANDARD RADIO APPARATUS**  
is made in standard resistances and ratings. Only the highest grade material is used, and first-class workmanship assures a product that guarantees high efficiency and durability.

Send for our latest radio Bulletin.  
If your dealer or letter does not handle Kellogg equipment, write us for catalogue, addressing our Chicago office Dept. R.

**Kellogg Switchboard & Supply Co., Chicago**



The **BENWOOD** CW Transmitter

Simple, compact, up-to-the-minute construction—incorporating all the improvements made possible by our years of experimenting and it gets results!

**1500 Miles With CW!**  
**1100 Miles Voice!**

Music Heard 40 Feet From Phones by Stations in 300 to 400 Mile Radius

THESE are actual results obtained by our testing station WEB using the Benwood CW Transmitter shown herewith. You can get just as good results with it. This high-class set is just the thing for your broadcasting and DX work—using CW, ICW, Modulated Buzz or Voice Transmission. An ideal set for the local radio club or the more progressive amateur. Think of the range this set will give you! If centrally located, you will be heard in almost every state in the Union. It is manufactured exclusively by and for the Benwood Co. and combines the best in material, workmanship and design.

**Radiates 1 1/2 to 3 Amps on Average Antenna**

We guarantee that this outfit will radiate 1 1/2 amperes on the average amateur antenna when assembled in accordance with our instructions. It will radiate 2 to 3 amperes when used with an antenna whose fundamental wave length is 275 to 375 meters. That is why you can get such wonderful results. The set comes to you completely assembled with all parts excepted on order, as shown, but not wired. Full instructions and wiring diagrams are furnished. You can wire it and start sending in less than an hour after you receive it. The outfit is complete with motor generator antenna tubes, and consists of the following: Panel 12x12x4, single supports, hardwood base, 2 tube sockets, 1 power rheostat, 1 1/2 watt filament transformer, 1 modulation transformer, 1 CW inductance, 1 hand transmitter, 1 5-3 radiation meter, 1 2-100 milliammeter, 1 21 plate condenser, 1 41 plate condenser, 1 tapped condenser, 1 1200 ohm coil, 1 2000 ohm filter condenser, 1 16,000 ohm grid leak, plug and jack connection for microphone buzzer and CW, 1 500 volt 220 watt motor-generator. Binned for shipment, \$29.00 f. o. b. St. Louis, Mo.

CATALOG: Send 10c in stamps for the Benwood CATALOG and price list, also complete catalog and price list of DeForest radio equipment. DEALERS: We manufacture a complete line of radio apparatus. We have stock on hand and ready to ship. Write or wire for our attractive proposition. New price list just issued.

The **BENWOOD** RADIO CO. INC.  
"WORLD-WIDE MAIL ORDER SERVICE"  
1114 OLIVE STREET ST. LOUIS, MO.

Figure 13. (left) Benwood station WEB. Notice the picture of the actual transmitter used by station WEB and the solicitation for retail radio equipment dealers on the bottom right.

Source: QST, October 1922, p. 137.

*"Reel Easy"*

## Vario Coupler

Our BANK WOUND Vario Coupler is

**Built for You**

Because We Feel It Is

**Just the Thing**

**We Absolutely Guarantee Satisfaction**

**You Are the Judge**

of its efficient operation, between 150  
and 3000 meters

Price \$6.00 Shipping Weight 3 Lbs.  
Postage Extra

**I. R. NELSON CO.** BOND STREET  
NEWARK, N. J.

**RADIOPHONE STATION W-A-A-M**

Figure 14. Station WAAM.

Source: Radio News,  
November 1922, p. 1012

Try **REYNOLDS RADIO** Service

9 ZAF

from DENVER

KLZ

Clapp - Eastham H R Receiver	\$40.00	Grebe CR5 Receiver	\$80.00
Kennedy Type 281	80.00	Grebe CR8	80.00
Kennedy Type 220	125.00	Grebe CR9	130.00
Kennedy Type 110	250.00	Accessories, Supplies - Everything in Radio	

Send 15c for our new RADIO GUIDE - Refunded on first order amounting to \$5.

**REYNOLDS RADIO CO., INC.** 1534 GLENARM STREET, DENVER, COLO.

LARGEST DISTRIBUTORS OF RADIO APPARATUS IN THE WEST

Figure 15. Station KLZ.

Source: Radio News, November 1922, p. 1017

**BESCO**

## VARIABLE CONDENSERS

43 Plate	-	-	\$2.95
23 Plate	-	-	2.45

WE GUARANTEE SATISFACTION  
OR MONEY REFUNDED.

ORDER TODAY  
RADIO-WEAC

**9CUX**

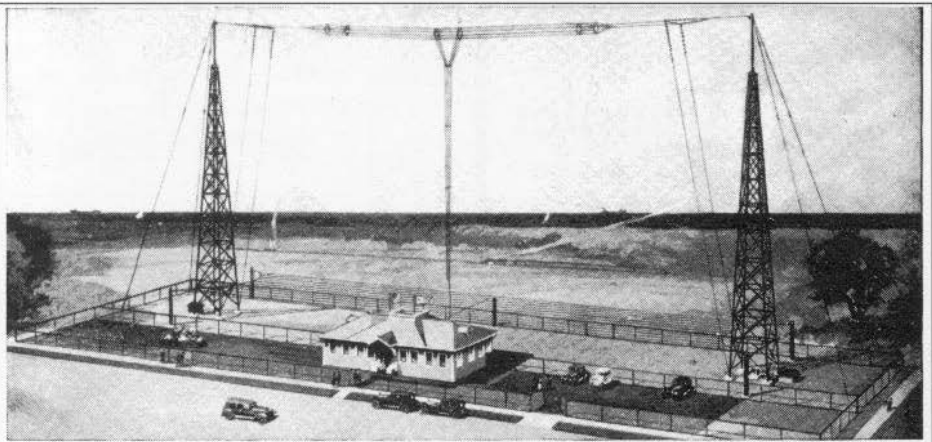
**BAINES ELECTRIC SERVICE CO.**

24 So. 8 St.,

Terre Haute, Ind.

Figure 16. Station WEAC.

Source: QST, October 1922,  
p. 96



WTAM, the broadcasting station of the Willard Storage Battery Company broadcasts on a wave length of 389.4 meters (770 kilocycles). Regular evening concerts are scheduled for Mondays, Wednesdays and Saturdays, 8:00 to 12:00 p. m. Noon day concerts and dinner concerts are broadcast daily except Sunday, 12:15 to 3:15 p. m. and 6:00 to 7:00 p. m. respectively. All programs on Eastern Standard Time.

**Figure 17. Station WTAM.**

Source: Better Results from Radio Booklet published by the Willard Storage Battery Co., Cleveland, OH, 1925, p. 28.

# no ground aerial

*The Oard* **PHANTOM** *no ground circuit*  
used in-

*The A-P Special*  
**RECEIVING SET**

One of the most important, most revolutionary developments since the discovery of radio... The receiving set (shown) have been waiting for. A set that requires no ground, no aerial. Its ground wire is a single wire not exceeding 15 feet in length, connected in the plate winding lead on the base, or if optional desired, also set on the ground, in all that is necessary. Stations 400 miles distant have been heard under these conditions. For distant service a wire not over 50 feet long will produce better results than can be obtained with the elements 150 to 200 feet metal and ground, or loop system required by other types of receivers.

The *A-P Special* has the apparent advantages of radio-frequency amplification, without its delay and complicated adjustments. It is remarkable for its simplicity of control and marked selectivity, and shield both as a base set and for use as a portable in camping or touring.

Patents pending. Copyright 1922 by Atlantic-Pacific Radio Supplies Co. No other set can be made or used in any form without the express written permission of Atlantic-Pacific Radio Supplies Co.

No other set can be made or used in any form without the express written permission of Atlantic-Pacific Radio Supplies Co.

**U.S. AND FOREIGN PATENTS PENDING**

**Atlantic-Pacific Radio Supplies Co.**  
Operating K.Z.Y. 646-650 Mission St. Radio  
Broadcasting Station San Francisco, Cal. Supplies

**Figure 18. Station K.Z.Y.**

Source: Radio News, October 1922, p. 679

**FREE**



**12-Cell-24-Volt Storage "B" Battery**

Positively given Free with each purchase of a WORLD "A" Storage Battery. You must send this ad with your order. World Storage "B" Batteries give you economy and performance unheard of before. They deliver unflinching power that is clear, pure and quiet. Tested and Approved by Leading Authorities.

Radiocast Station  
**W S B C**

Set your Radio Dials at 210 meters for the 1000-watt World Storage Battery Station, WSBC, Chicago. On the air nightly, between 6:30 P. M. and 8:30 P. M. and 10:30 P. M. and 1:30 A. M., with intensely interesting programs for your approval and enjoyment.

You save  
**50%**



WORLD "A" Batteries are famous for their guaranteed quality and service. Backed by years of successful manufacture—thousands of satisfied users. Built of finest materials possible to obtain from raw material producers of national reputation. Equipped with solid rubber one-piece containers, an insurance against acid leakage and breakage. You save fifty per cent and get a



**2-Yr. Guarantee Bond in Writing**

with each Radio "A" and Auto Battery. WORLD Battery owners "tell their friends." That's our best proof of performance and is chiefly responsible for the tremendous growth of the Company. Compare these prices—then send your order in TODAY.

**Solid Rubber Case**

**Radio Batteries**

6-Volt, 120-Amperes . **\$11.25**  
6-Volt, 120-Amperes . **13.25**  
6-Volt, 140-Amperes . **14.00**

**Solid Rubber Case**

**Auto Batteries**

6-Volt, 11-Plate . . . **\$11.25**  
6-Volt, 15-Plate . . . **13.25**  
12-Volt, 7-Plate . . . **16.00**

**SEND NO MONEY!**

Just state battery wanted and we will ship day order is received, by Express, C. O. D., subject to your examination, on arrival. FREE "B" Battery is included.

**EXTRA OFFER**—Five per cent discount for cash in full with order. Buy NOW and get a guaranteed battery at fifty per cent saving to you.

**WORLD BATTERY COMPANY**  
1219 S. Wabash Ave., Dept. 10, Chicago

**World Batteries for Radio**

Figure 19. (above) Station WSBC.

Source: Radio News, October 1922, p. 679

Figure 20. (right) Station KOG.

Source: QST, April 1922, p. 114.

**The Sixth Edition  
Is Ready!**

It includes all the  
**LATEST PRICES  
ON EVERYTHING**

**SEND NOW  
FOR YOUR FREE COPY**  
of this

**INDISPENSABLE  
PRICE DICTIONARY**

**Western Radio Electric Co.**

637 So. Hope St. 274 Twelfth St.  
Los Angeles, Cal. Oakland, Cal.

**OPERATING KINEMA THEATER  
RADIOPHONE**

Call KOG—Los Angeles

KQV—Pittsburgh                      Broadcasting Stations                      Washington, D. C.—WMU  
**For Best Results Use the Stromberg-Carlson Radio Headset**



Stromberg-Carlson  
 No. 2A Headset

**\$7.50**

The Stromberg-Carlson No. 2-A Headset reproduces broadcasted, long-distance vocal or musical sounds with unequalled distinctness. Fine tonal qualities, extreme sensitiveness and superior construction are its important features.

Order Above and Following Highest Grade Supplies by Mail  
 Immediate Deliveries on all Items Listed

Aerola Senior Westinghouse Receiver.....	\$25.00
Aerola Grand Westinghouse Receiver.....	325.00
DeForest Radiohome DT 700 less Batteries, Bulbs and Headset.....	34.00
Simplex Variometers.....	35.00
King Amplitone Horns.....	5.00
Holtzer-Cabot Headset.....	12.00
UV 201 Radiotron Detector Bulbs each.....	7.50
No. 766 Eveready VT Batteries, each.....	6.50
Gould 6 volt, 60-90 ampere storage batteries.....	3.00
	23.00

Enclose Certified Check or P. O. Money Order including Postage

**DOUBLEDAY-HILL ELECTRIC CO.**

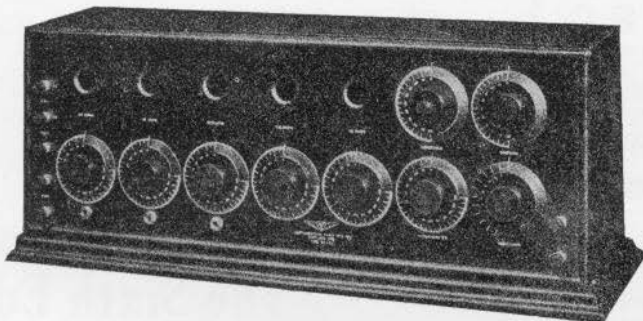
WASHINGTON, D. C.

Distributors

PITTSBURGH, PA.

Figure 21. Station KQV/WMU. Source: QST, July 1922, p. 112.

## Introducing the "SR 25"



**WE INVITE YOUR ENQUIRIES**

**Hallock and Watson Radio Service**

192 Park Street

"KGG"

Portland, Ore.

Figure 22. Station KGG. Source: Radio, October 1923, p. 90



**WOC**  
**TRESCO**

Licensed under Armstrong U. S. Patent  
 No. 1,113,149.

A Long Distance 1,000-mile, 600-meter Range  
 Regenerative Tuner for \$10.00. Add Parcel Post on  
 6 lbs. New Circuit, Startling Results. Cheaper  
 than Crystal Set. Uses any Aerial. Amplifiers to  
 match set for your loud speakers. Circulars free.  
 Full instructions.

**TRESCO**  
 DAVENPORT, IOWA

Figure 23. Station WOC.  
 Source: Radio,  
 October 1923, p. 93

**TABLE I****Early North American Radio Stations Operated and Owned by  
Radio Manufacturers and Marketers**

<u>CALLS</u>	<u>MANUFACTURER</u>	<u>LOCATION</u>	<u>TIME FRAME</u>
CFCF	Canadian Marconi	Montreal, Quebec	1923
CFCK	Radio Supply Co.	Edmonton, Alberta	1923
CFDC	West. Auto Elect. Co.	Vancouver, BC	1926
CFMC	Monarch Battery Co.	Kingston, ON	1926
CFQC	The Electric Shop	Saskatoon, Sask	1923
CFRB	Standard Radio Mfg. Co.	Toronto, ON	1931
CHCB	Marconi Co.	Toronto, ON	1923
CHCF	Marconi Co.	Montreal, Quebec	1923
CHNC	Toronto Radio Research Soc.	Toronto, ON	1927
CHNS	Northern Elec. Co., Ltd	Halifax, N.S.	1927
CHYC	Northern Elec. Co., Ltd.	Montreal, Quebec	1927
CJWC	Wheaton Elect. Co.	Montreal, Quebec	1927
CJYC	DeForest Radio Corp.	Scarford Stat., Quebec	1926
CKCL	Dominion Battery Co.	Toronto, ON	1926
CKLC	Wilkinson Electric Co. Ltd.	Calgary, Alberta	1927
CKOC	Wentworth Radio Sply	Hamilton, ON	1923
KARK	Arkansas Radio, Equip. Co.	Little Rock, AR	1932
KBTM	Beard's Temple of Music	Paragould, AR	1932
KDKA	Westinghouse	Pittsburgh, PA	1920
KDPM	Westinghouse	Cleveland, OH	1923
KDPT	Southern Electrical Co.	San Diego, CA	1923
KDZE	The Rhodes Co.	Seattle, WA	1924
KDZI	Electric Sply Co.	Wonatchee, WA	1923
KDZK	Nevada machinery, Elect.	Reno, NV	1922
KER	Federal Telegraph	Hillsboro, OR	1923
KFAD	McArthur Bros. Mercantile Co.	Phoenix, AZ	1923
KFAN	The Electric Shop	Moscow, ID	1922
KFBH	Thomas Musical Co.	Marshfield, OR	1923
KFC	Nielsen Radio Sply. Co.	Phoenix, AZ	1923
KFCH	Electric Service Station, Inc.	Billings, MT	1924
KFCM	Richmond Radio Shop	Richmond, CA	1923
KFDA	Adler's Music Store	Baker, OR	1923
KFDC	Radio Sply Co.	Spokane, WA	1923
KFDL	Knight-Campbell Music Co.	Denver, CO	1923



KFDP	Hawkeye Radio Supply Co.	Des Moines, IA	1923
KFDR	Bullock's Hdwre, Sportg Goods	York, NE	1923
KFEL	W. L. Winner Radio Shop	Denver, CO	1925
KFEP	Radio Euip. Co.	Denver, CO	1923
KVEV	Radio Elect. Shop	Douglas, WY	1923
KFFB	Jenkins Furniture Co.	Boise, ID	1923
KFGD	Chickasha Radio & Elect. Co.	Chickasha, OK	1923
KFGQ	Crary Hardwre	Boone, IA	1923
KFGV	Heildbreder Radio Sply. Co.	Utica, NE	1923
KFGY	Gjelhaug's Radio Shop	Baudette, MN	1923
KFHD	Utz Elec. Co.	St. Joseph, MO	1923
KFHP	Radio Bug Products Co.	Kearney, NE	1923
KFHR	Star Elec. & Radio Co.	Seattle, WA	1923
KFIZ	WI Radio Sales, Daily Commonwlth	Fon Du Lac, WI	1925
KFJB	Marshall Elec. Co.	Marshalltown, IA	1926
KFJF	National Radio Mfg. Co.	Oklahoma City, OK	1923
KFJK	Delano Radio, Elect.	Bristow, OK	1924
KFKQ	Conway Radio Labs	Conway, AR	1924
KFKX	Westinghouse	Hastings, NE	1924
KFLB	Signal Elect. Co.	Menominee, MI	1924
KFLQ	Bizzell Radio Shop	Little Rock, AR	1924
KFLW	Missoula Elect Sply Co.	Missoula, MT	1924
KFLY	Fargo Radio Sply. Co.	Fargo, ND	1924
KFMS	Freimuth Dept. Store	Duluth, MN	1924
KFNF	Henry Field Seed Co.	Shenandoah, IA	1924
KFNV	L.A. Drake Battry, Radio Sply	Santa Rosa, CA	1925
KFOA	Rhodes Department Store	Seattle, WA	1925
KFON	Echophone Radio Shop	Long Beach, CA	1924c
KFOR	David City Tire & Elec.	David City, NE	1926
KFOY	Beacon Radio Service	St. Paul, MN	1925
KFPM	New Furniture Co.	Greenville, TX	1925
KFQC	Kidd Brothers Radio Shop	Taft, CA	1925
KFQH	Radio Service Co.	Burlingame, CA	1925
KFQW	C. F. Knierim Photo, Radio, Elect.	North Bend, WA	1926
KFRC	The Radio Shop	Grafton, ND	1925
KFS	Federal Telegraph	San Francisco, CA	1921
KFUL	Thos. Goggin, Bros Music Co.	Galveston, TX	1926
KFUU	Colburn Radio Labs	San Leandro, CA	1926
KFVH	Whan Radio Shop	Manhattan, KS	1926
KFVS	Hirsch Battery & Radio Co.	Cape Girardeau, MO	1932
KFVY	Radio Supply Co.	Albuquerque, NM	1926

KFZ	Doerr Mitchell Elect Co.	Spokane, WA	1923
KGA	Northwest Radio Service	Spokane, WA	1927
KGCI	Liberto Radio Sales	San Antonio, TX	1927
KGCR	Cutler's Radio Service	Brookings, SD	1927
KGEK	Boehler Elect. Equip.	Yuma, CO	1927
KGG	Hallock and Watson Radio Service	Portland, OR	1923
KGH	Federal Telegraph	Hillsboro, OR	1923
KGMP	Bryant Radio & Elect. Co.	Elk City, OK	1932
KGN	Northwestern Radio Mfg. Co.	Portland, OR	1923
KGO	Altadena Radio Lab/ General Electric	Oakland, CA	1922
KGRS	Gish Radio Service	Amarillo, TX	1927
KII	The Radio Shop	Sunnyvale, CA	1923
KJJ	The Radio Shop (Ecophone)	Sunnyvale, CA	1921
KJR	Northwest Radio Service Co.	Seattle, WA	1923
KLP	Colin P. Kennedy	Los Altos, CA	1922
KLS	Warner Bros. Radio Sply.	Oakland, CA	1924
KLZ	Reynolds Radio Service	Denver, CO	1922
KMTR	Love Elec./Echophone Mfg. Co	Los Angeles	1926
KMA	The May Seed Co.	Shenandoah, IA	1925
KMO	Love Electric Co.	Tacoma, WA	1923
KMTR	Love Electric/Echophone Mfg.	Los Angeles, CA	1926
KNR	Federal Telegraph	Clearwater, CA	1923
KNV	Radio Sply Co. of CA	Los Angeles, CA	1923
KOA	General Electric	Denver, CO	1924
KOG	Western Radio Elect. Co.	Los Angeles, CA	1922
KOK	Federal Telegraph	Clearwater, CA	1922
KPJM	Wilburn Radio Service	Prescott, AZ	1927
KPH	American DeForest	San Francisco, CA	
KQV	Doubleday-Hill	Pittsburgh, PA	1922
KQW/ (KCBS)	San Jose, CA	Charles D. Herrold	1921
KQY	Nielson Radio & Sply. Co.	Phoenix, AR	1921
KRLD	Dallas Radio Labs, Inc.	Dallas, TX	1927
KRSC	Radio Sales Corp.	Seattle, WA	1927
KSS	Prest & Dean Radio Rsch Lab	Long Beach, CA	1923
KSTP	National Battery Bdcstg. Co.	Minneapolis/ St. Paul, MN	1924
KTBR	Brown's Radio Shop	Portland, OR	1926
KTNT	Norman Baker	Muscataine, IA	1925
KTUE	Uhalt Elect.	Houston, TX	1927
KVOO	Southwest Sales Corp.	Bristow, OK	1927

KWT	Federal Telegraph	Palo Alto, CA	1921
KYQ	Electric Shop	Honolulu, HI	1923
KYW	Westinghouse	Chicago, IL	1921
KYY	The Radio Telephone Shop	San Francisco, CA	1921
KZV	Wenatchee Battery & Motor Co.	Wenatchee, WA	1923
KZY	Atlantic & Pacific Radio Sply.	Oakland, CA	1921
WAAK	Gimbel Brothers	Milwaukee, WI	1922
WAAL	Beamish Elect Co.	Minneapolis, MN	1923
WAAM	I.R. Nelson Co.	Newark, NJ	1922
WAAT	Frank Bremer (radio shop)	Jersey City, NJ	1926
WAAY	Yahrling-Rayner Co.	Youngstown, OH	1922
WABC	Fulwiler-Grimes Battery Co.	Anderson, IN	1923
WABC	Asheville Battery Co.	Asheville, NC	1926
WABC	(WAHG)Atlantic Brodcasting Corp.	Richmond Hills, NY	1927
WABG	Arnold Edwards Piano Co.	Jacksonville, FL	1923
WABJ	Radio Laboratories	South Bend, IN	1923
WABM	F.E. Doherty Auto & Radio	Saginaw, MI	1923
WABU	Victor Talking Mach. Co.	Camden, NJ	1924
WAHG	A. H. Grebe Co.	Richmond Hills, NY	1924
WAIA	Heers Stores Co.	Springfield, MO	1923
WARC	American Radio & Res.	Medford, MA	1926
WARS	Amateur Radio Spec. Co.	Brooklyn, NY	1926
WASN	Shepard Stores	Boston, MA	1927
WBAL	Superior Radio & Tel. Co.	Columbus, OH	1923
WBAN	Wireless Phone Co.	Patterson, NJ	1922
WBAV	AT&T	New York, NY	1923
WBAY	AT&T	New York, NY	1922
WBBA	Newark Radio Labs	Newark, OH	1923
WBBC	Sterling Radio Equip. Co.	Sterling, IL	1923
WBBD	Barbey Battery Service	Reading, PA	1923
WBBM	Stewart-Warner Speedometer	Chicago, IL	1923
WBBX/			
WLS	Sears, Roebuck	Chicago, IL	1923
WBMH	Braun's Music House	Detroit, MI	1927
WBOQ	A.H. Grebe Co.	Richmond Hills, NY	1924c
WBRL	Booth Radio Labs	Tilton, NH	1927
WBRS	Universal Radio Mfg. Co.	Brooklyn, NY	1926
WBS	Mullins Furn. Store	Newark, NY	1922
WBZ	Westinghouse	Springfield, MA	1921
WBZA	Westinghouse	Boston, MA	1925
WCAC	John Fink Jewelry Co.	Fort Smith, AR	1922

WCAE	Kaufman & Baer Co.	Pittsburgh, PA	1923
WCAH	Entrekin Elect. Co.	Columbus, OH	1923
WCAP	AT&T	Washington, DC	1924
WCAR	Alamo Radio Electric Co	San Antonio, TX	1923
WCAV	Dice Elect. Co.	Little Rock, AR	1923
WCAW	Quincy Elect. Sply Co.	Quincy, IL	1923
WCBB	K. & K. Radio Supply Co.	Greenville, OH	1923
WCBL	Northern Radio Mfg. Co.	Houlton, ME	1924
WCBU	Arnold Wireless Sply. Co.	Arnold, PA	1925
WCE	Findley Elect. Co.	Minneapolis, MN	1923
WCJ	A. C. Gilbert Co.	New Haven, CT	1921
WCK	Stix, Baer & Fuller	St. Louis, MO	1922
WCX	Jewett Radio, Phono Co.	Pontiac, MI	1924
WDAD	Central Kansas Radio Supply	Linsburg, KS	1923
WDAI	Hughes Elect. Corp.	Syracuse, NY	1923
WDAM	Western Elect. Corp.	New York City, NY	1923
WDAO	Automotive Elec. Co	Dallas, TX	1923
WDAR	Lit Bros.	Philadelphia, PA	1923
WDAY	Radio Equipment Corp.	Fargo, ND	1923
WDBE	Gilham-Schoen Elect. Co.	Atlanta, GA	1926
WDBF	Robert G. Phillips	Youngstown, OH	1923
WDBJ	Richardson-Wayland Elect.	Roanoke, VA	1924
WDBK	M.F. Broz Furn, Hdwre, Radio	Cleveland, OH	1924
WDBQ	Morton Radio Sply. Co.	Salem, NJ	1925
WDBX	Dyckman Radio Shop	Inwood (NYC), NY	1924
WDRC/			
WPAJ	Doolittle Radio Co.	New Haven, CT	1922
WDT	Ship Owners Radio Service	New York City, NY	1921
WDY	RCA	Roselle Park, NY	1921
WEAB	Standard Radio Equip. Co	Fort Dodge, IA	1923
WEAC	Baines Electric Service Co.	Terre Haute, IN	1922
WEAD	Henry Radio & Elect. Sply	Atwood, KS	1923
WEAN	Shepard Stores	Providence, RI	1923
WEAF	AT&T	New York City, NY	1922
WEAR	Willard Storage Battery	Cleveland, OH	1926
WEAS	The Hecht Co.	Washington, DC	1922
WEB	The Benwood Co., Inc.	St. Louis, MO	1922
WEBA	The Electric Shop	Highland Park, NJ	1925
WEBD	Elect. Equipment, Servc. Co.	Anderson, IN	1925
WEBL	Radio Corp. of America	(portable sta.)	1925
WEBM	Radio Corp. of America	(portable sta)	1926
WENR	All American Bdcstg.	Chicago, IL	1925

WEV	Hurlburt-Still Elect.Co.	Houston, TX	1923
WFAG	Radio Eng. Lab.	Waterford, NY	1923
WFAH	Electric Sply Co.	Port Arthur, TX	1923
WFAJ	Hi Grade Wireless Inst. Co.	Asheville, NC	1923
WFAZ	South Carolina Radio Shop	Charleston, SC	1923
WFBE	Van De Walle Music, Radio Co.	Seymour, IN	1925
WFBI	Galvin Radio Sply Co.	Camden, NJ	1925
WFBN	Radio Sales, Service Co.	Bridgewater, MA	1925
WFBW	Ainsworth-Gates Radio	Cincinnati, OH	1924
WFI	Strawbridge & Clothier Co.	Philadelphia, PA	1923
WFMN(W2XMN)			
	Armstrong	Alpine, NJ	early 1940's
WFRL	Flatbush Radio Laboratory	Brooklyn, NY	1925
WGAC	Orpheum Radio Stores	Brooklyn, NY	1922
WGAF	Goller Radio Service	Tulsa, OK	1923
WGAM	Orangeburg Radio Equip. Co.	Orangeburg, SC	1923
WGAU	Radio Mfg. & Service Co.	Wooster, OH	1923
WGAX	Radio Elect. Co	Washington Court House, OH	1923
WGBA	Jones Elect, Radio Mfg. Co.	Baltimore, MD	1925
WGBB	Beartras & Harry Carman	Hempstead, LI, NY	1924
WGBF	The Finke Furniture Co.	Evansville, IN	1923
WGBG	Breitenbach's Radio Shop	Thrifton, VA	1925
WGBS	Gimbel Bros.	Astoria, NY	1924
WGBW	Hub Radio Shop, Valley Theatre	Spring Valley, IL	1925
WGH/WPAB/WNEW			
	Radio Corp., VA	Norfolk, VA	1926
WGI/WARC			
	AMRAD	Medford, Hills, MA	1922
WGMU	A. H. Grebe	(mobile)	1928
WGR	Federal Tel & Tel	Buffalo, NY	1924
WGU	The Fair	Chicago, IL	1922
WGY	General Electric	Schenectady, NY	1922
WHAC	Cole Bros. Elect Co	Waterloo, IA	1923
WHAH	Hafner Supply Co.	Joplin, MO	1923
WHAJ	Radio Equipment & Mfg. Co.	Davenport, IA	1923
WHAK	Roberts Hdwre.	Clarksburg, WV	1923
WHAM	Stromberg Carlson	Rochester, NY	1927
WHAR	Paramount Radio & Elect. Co	Atlantic City, NJ	1923
WHAV	Wilmington Elect. Specty. Co	Wilmington, DE	1923
WHB	Sweeney Radio & Electrical	Kansas City, MO	1922
WHBA	Shaffer Music House	Oil City, PA	1925

WHBR	Scientific Electric, Mfg. Co.	Cincinnati, OH	1925
WHBV	Fred Ray's Radio Shop	Columbus, GA	1925
WHEC	Hickson Elect. Co.	Rochester, NY	1926
WHU	William B. Duck Co.	Toledo, OH	1922
WIAH	Continental Radio Mfg. Co.	Newton, IA	1923
WIAI	Heers Stores Co.	Springfield, MO	1923
WIAJ	Fox River Valley Radio Sply	Neenah, WI	1923
WIAS	Poling Elect. Co.	Ottumwa, IA	1932
WIAV	New York Radio Labs	Binghamton, NY	1922
WIAW	Saginaw Radio, Elect. Co.	Saginaw, MI	1923
WIBD	X-L Radio Service	Joliet, IL	1925
WIBH	Elite Radio Stores	New Bedford, MA	1925
WIBI	The Murray Hill Elec. Co.	Queens, NY	1925
WIBZ	Powell Elect. Co	Montgomery, AL	1926
WIK	K. & L. Elect. Co.	McKeesport, PA	1923
WIL	Continental Elect Sply	Washington, DC	1922
WIP	Gimbel Brothers	Philadelphia, PA	1922
WIZ	Cino Radio Mfg. Co.	Cincinnati, OH	1922
WJAB	American Elect. Co.	Philadelphia, PA	1923
WJAD	Jackson's Radio Engng. Labs	Waco, TX	1923
WJAK	White Radio Lab.	Stockdale, OH	1923
WJAR	The Outlet Co.	Providence, RI	1922
WJAS	Pittsburgh Radio Supply Hse	Pittsburgh, PA	1921
WJAZ	Zenith-Edgewater Beach Hotel	Chicago, IL	1923
WJBC	Hummer Furn. Co.	La Salle, IL	1926
WJBL	Wm. Gushard Dry Goods	Decatur, IL	1926
WJBV	Union Course Laboratories	Queens, NY	1923
WJH	White and Boyer Co.	Washington, DC	1921
WJK	Service Radio Equip. Co.	Toledo, OH	1922
WJR	Jewett Radio, Phono	Pontiac, MI	1926
WJX	Deforest Radio Tel & Tel	Bronx, NY	1920
WJY	RCA	New York, NY	1921
WJX	DeForest Radio Tel & Tel	New York City, NY	1921
WJY	Radio Corp. of America	New York, NY	1923
WJZ	Westinghouse/RCA	Newark, NJ	1921
WKAF	W. S. Radio Sply. Co.	Wichita Falls, TX	1923
WKAN	United Battery Service Co.	Montgomery AL	1923
WKAQ	Radio Corp. of America	San Juan, PR	1923
WKAS	Lines Music Co., L. E.	Springfield, MO	1923
WKBA	Arrow Battery Co.	Chicago, IL	1926
WKBE	K & B Elect. Co.	Webster, MA	1926
WKBH	Callaway Music Co.	LaCrosse, WI	1926
WKBL	Monroe Radio Mfg. Co.	Monroe, MI	1926

WKBN	Radio Electric Service Co.	Youngstown, OH	1926
WKBV	Knox Battery & Elect. Co.	Brookville, IN	1928
WKC	Jos. M. Zamoiski Co.	Baltimore, MD	1922
WKN	The Reichman-Crosby Co	Memphis, TN	1922
WKRC	Kodel Radio Corp.	Cincinnati, OH	1925
WKST	Kirk Hutton, Sam Townsed	New Castle, PA	1938
WKY	WKY Radio Shop	Oklahoma City, OK	1923
WLAG	Cutting & Washington	Minneapolis, MN	1923
WLAJ	Waco Elect. Sply. Co.	Waco, TX	1923
WLAN	Putnam Hdwre Co.	Houlton, ME	1923
WLAQ	A. E. Schilling Elect.	Kalamazoo, MI	1923
WLAT	Radio & Specialty Co.	Burlington, IA	1923
WLAV	Electric Shop, Inc.	Pensacola, FL	1923
WLAZ	Hutton & Jones Electri	Warren, OH	1923
WLBM	Browning-Drake Corp.	Boston, MA	1927
WLBX	Radio Service Labs	Long Island City, NY	1926
WLBY	Aimone Elect. Co	Iron Mountain, MI	1927
WLIT	Lit Bros.	Philadelphia, PA	1925
WLAS	Central Radio Sply Co.	Hutchinson, KS	1923
WLK	L. S. Ayres/Hamilton/News	Indianapolis, IN	1921
WLS/			
WBBX	Sears Roebuck	Chicago, IL	1923
WLTH	Flatbush Radio Lab	Brooklyn, NY	1927
WLW	Crosley Mfg. Co.	Cincinnati, OH	1922
WMAB	Radio Sply Co.	Oklahoma City, OK	1923
WMAH	General Sply Co.	Lincoln, NE	1923
WMAK	Norton Laboratories	Lockport, NY	1923
WMAL	Trenton Hardware Co.	Trenton, NJ	1923
WMAM	Beaumont Radio Equipment Co.	Beaumont, TX	1923
WMAP	Utility Battery Service, Inc.	Easton, PA	1923
WMAR	Waterloo Elect. Sply Co.	Waterloo, IA	1923
WMAX	K. & K. Radio Sply Co.	Ann Arbor, MI	1923
WMBS	Mack Battery Co.	Harrisburg, PA	1927
WMBD	Peoria Heights Radio Lab	Peoria Heights, IL	1927
WMBR	Premier Elect. Co.	Tampa, FL	1927
WMBS	Mack Battery Co.	Harrisburg, PA	1927
WMBW	Youngstown Bdcstg. (Yaw Battery)	Youngstown, OH	1927
WMC	Columbia Radio Co.	Youngstown, OH	1922
WMH	Precision Equipment Co.	Cincinnati, OH	1922
WMH			
(2ND)	Ainsworth-Gates Co.	Cincinnati, OH	1924
WMRJ	Merrick Radio Store	Jamaica, NY	1926

WMU	Doubleday-Hill Elect. Co.	Washington, DC	1922
WNAC	Shepard Stores	Boston, MA	1923
WNAM	Ideal Apparatus Co.	Evansville, IN	1923
WNAQ	Charleston Radio Elect. Co	Charleston, SC	1923
WNAX	Dakota Radio Apparatus Co.	Yankton, SD	1923
WNAY	Ship Owners Radio Serv.	Baltimore, MD	1923
WNBC	(WEAF) RCA	NY, NY	1922
WNBF	Howitt-Wood Radio Co.	Binghamton, NY	1927
WNBR	Popular Radio Shop	Memphis, TN	1927
WNJ	Shotten Radio Mfg.	Albany, NY	1923
WNJ	Radio Shop of Newark	Newark, NJ	1925
WNN	Ship Owners Radio Service	Norfolk, VA	1922
WOAC	Page Organ Co.	Lima, OH	1925
WOAD	Friday Battery & Elect. Co.	Sigourney, IA	1923
WOAI	Southern Equipment Co.	San Antonio, TX	1922
WOAJ	Ervins Elect. Co.	Parsons, KS	1923
WOAK	Collins' Hardware Co.	Frankfort, KY	1923
WOAO	Lyradion Mfg. Co.	Mishawaka, IN	1923
WOAS	Bailey's Radio Shop	Middletown, CT	1923
WOAU	Sowder-Bolling Piano Co.	Evansville, IN	1923
WOAX	Radio Equipo. Co.	Peoria, IL	1923
WOC	Tresco	Davenport, IA	1923
WODA	O'Dea Temple of Music	Patterson, NJ	1925
WOH	Hatfield Electric Co.	Indianapolis, IN	1922
WOK	Advance Auto (Neutrowound)	Homewood, IL	1925
WOKO	Dyckman Radio Shop	NYC, NY	1924
WOO	John Wanamaker	Philadelphia, PA	1922
WOR	Bamberger's Dept. Store	Newark, NJ	1922
WOUA	Sowder-Bolling Piano Co.	Evansville, IN	1923
WOWL	Owl Batteries	New Orleans, LA	1925
WOWO	Main Auto Supply	Fort Wayne, IN	1925
WPAL	Superior Radio & Tel Equip.	Columbus, OH	1923
WPAQ	General Sales & Engrg. Co.	Frostberg, MD	1923
WPAR	Ward Battery & Radio Co.	Beloit, KS	1924
WPAS	J. & M. Elect. Co.	Amsterdam, NY	1923
WPAW	Delaware Radio Install. Co.	Wilmington, DE	1923
WPAZ	West Virginia Radio Sales Corp.	Charleston, WV	1924
WPI	Electric Sply. Co.	Clearfield, PA	1923
WPM	Thos. J. Williams	Washington, DC	1922
WQAC	Gish Radio Service	Amarillo, TX	1923
WQAD	Whiteall Elect. Co	Waterbury, CT	1923
WQAH	Brock-Anderson Elect. Eng. Co.	Lexington, KY	1923



WQAK	Appel Higley Elect. Co	Dubuque, IA	1923
WQAM	Electrical Equip. Co.	Miami, FL	1923
WQAT	Radio Equip. Corp.	Westhampton, VA	1923
WQAX	Radio Equip. Co.	Peoria, IL	1923
WQAY	Gaston Music & Furniture Co.	Hastings, NE	1923
WQB	Tuska Radio	Hartford, CT	1920
WQUY	Gaston Music & Furniture Co.	Hastings, NE	1923
WQXR	John Vincent, Lawlor Hogan	New York, NY	1936
WRAD	Taylor Radio Shop	Marion, KS	1923
WRAN	Black Hawk Elect. Co.	Waterloo, IA	1923
WRAO	Radio Serv. Co.	St. Louis, MO	1923
WRAP	The Elect. Const. Co.	Winter Park, FL	1923
WRAR	Radio, Elect. Shop	David City, NE	1923
WRAS	Radio Supply Co.	McLeansboro, IL	1923
WRAW	Avenue Radio, Elect. Shop	Reading, PA	1925
WRAY	Radio Sales Corp.	Scranton, PA	1923
WRAZ	Radio Shop of Newark	Newark, NJ	1923
WRC	RCA	Washington, DC	1923
WREC	Wooten's Radio Elect. Co.	Coldwater, MS	1925
WRK	Doron Brothers	Hamilton, OH	1922
WRMU	A. H. Grebe Co.	Richmond Hills, NY (boat)	1926
WRNY	(Experimenter Publishg)	New York City, NY	1925
WRSC	The Radio Shop	Chelsea, MA	1927
WRST	Radiotel Mfg. Co.	Bayshore, L. I., NY	1925
WRW	Radio Research Labs	Tarrytown, NY	1922
WSAA	Sprague Elect Co. B.S.	Marietta, OH	1923
WSAI	Crosley Manufacturing Co.	Cincinnati, OH	1923
WSAL	Franklin Electrical Co.	Brookville, IN	1923
WSAR	Doughty & Welch Electr. Co.	Fall River, MA	1925
WSAV	Clifford Vick Radio Const. Co.	Houston, TX	1925
WSAX	Chicago Radio Lab(Zenith)	Chicago, IL	1923
WSAZ	Chase Electric Shop	Pomeroy, OH	1925
WSAZ	McKellar Electric	Huntington, WV	1927
WSBC	World Battery Co.	Chicago, IL	1925
WSBF	Stix, Baer. & Fuller Co.	St. Louis, MO	1925
WSL	J. & M. Elect Co.	Utica, NY	1923
WSMH	Shattuck Music House	Owosso, MI	1925
WSN	Ship Owners Radio Service	Norfolk, VA	1922
WSRO	(Radio Supply Store)	Hamilton, OH	1926
WSZ	Marshall-Gerkin Co.	Toledo, OH	1922

WTAG	Kern Music Co.	Providence, RI	1923
WTAJ	The Radio Shop	Portland, ME	1923
WTAL	Toledo Radio & Elect. Co.	Toledo, OH	1923
WTAM	Willard Battery Co.	Cleveland, OH	1923
WTAP	Cambridge Radio & Elect.	Cambridge, IL	1925
WTAR	Reliance Electric	Norfolk, VA	1923
WTAU	Ruegg(sp?) Battery & Elect. Co.	Tecumseh, NE	1923
WTAX	Williams Hdwre Co.	Streator, IL	1925
WTMJ	Technical Radio Lab	Milwaukee, WI	1927
WTVR/			
WMBG	Wilbur Havens (batteries)	Richmond, VA	1926
WWI	Ford Motor Co.	Dearborn, MI	1922
WWRL	Woodside Radio Laboratory	Queens, NY	1926
WWSW/			
WMBJ	Walker & Downing Radio Corp.	Pittsburgh, PA	1930
WWZ	John Wanamaker	New York City, NY	1922
WYAM	Electrical Equip. Co.	Miami, FL	1924

WLAG, Minneapolis owner/radio manufacturer, "Cutting & Washington," facing an endless financial drought, surrendered their withering, practically bankrupt radio station. The station later blossomed into a world-class outlet, WCCO (for Washburn-Crosby Company, makers of "Gold Medal Flour").

In the station's darkest day, the flour company's vice president, Donald D. Davis, convinced his president that radio could be a valuable marketing tool in the "flour war" with Pillsbury, also in Minneapolis, despite the fact that "Radio in 1924 did not make money. It consumed *it* as a fireplace does wood." According to Davis, "...we believed that anything so manifestly for the good of the public would somehow be good for us."<sup>23</sup> WCCO became a tall oak, one of the happy endings.

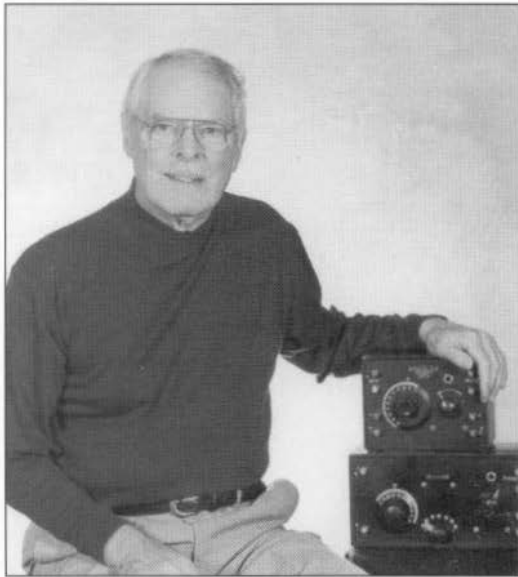
#### Author's note:

Please write with your station and entrepreneur additions, clarifications, and corrections, along with any background to: George Freeman; c/o RALOGEUM, 133 E. Main St., 2nd Floor, Madison, IN 47250-3411, Phone (812) 265-6878, E-Mail [ralogeum@aol.com](mailto:ralogeum@aol.com)

### REFERENCES and NOTES

1. Julian, J., *This Was Radio* (New York: Viking Press, 1975) pg. 27.
2. Stone, G. 1921.
3. *Radio World* magazine; Falls Church, VA. 4/12/00/BIA Financial Network. WFAN, a sports/talk station, was the first station to bill \$50 million. It's 1999 billings are estimated to have been \$60.8 million.

4. Banning, W., *Commercial Broadcasting Pioneer-The WEAJ Experiment* (Cambridge, MA: Harvard University Press, 1946) p. Xxxiii.
5. *New Haven Register*, Sunday Feb. 22, 1953.
6. *Electrical World* 4/25/25., Lyon, E. "Radio Age" 5/95. p. 4.
7. *Popular Radio* 4/25/25. p. 392.
8. "The First Quarter Century of American Broadcasting".
9. *ARCA Gazette*, Spring, 1991. Ralph Williams.
10. Jaker, Sulek, Kanze, *The Airwaves of New York* (Jefferson, NC: McFarland (1998) p.34.
11. Gray, G. J. "The Grebe Radio Story" *The Old Timer's Bulletin* Vol. 3, winter 1962/63. AWA Monograph #6.
12. Douglas, A., *Radio Manufacturers of The 1920s* (Vestal, NY: The Vestal Press, Ltd. pp. 50, 51.
13. Sanger, E., *Rebel in Radio —The Story of WQXR*. (New York: Hastings House, 1973) pg. 13.
14. Brouder, E. Granite and Ether, Bedford, NH. The New Hampshire Association of Broadcasters, 1993.
15. <http://www.wdrcobg.com>.
16. Grcevich, S. *An Historical Study of The Development of Broadcasting in Youngstown Prior to 1928* 3/1971 Masters Thesis. (Grcevich, known as Jay Stevens on the air, worked with the author at WBBW-AM, Youngstown, OH in the 1950s)
17. Mrs. Mary Evelyn Grcevich in early 1990s phone conversation with author, recalling her husband's conversations.
18. An important Youngstown product for broadcasters all across America was towers made by Truscon steel. Two of these were installed in Hartford, CT at WDRC.
19. The other Ohio stations on 3/27/22 were WMH, Cincinnati, WDZ, Toledo, and WHK, Cleveland.
20. Columbia Radio was located on Youngstown's south side at the corner of South and Indianola Avenues.
21. Gladys Ainsworth Wells, Leo's daughter, in July 11, 1994; conversation with author.
22. Douglas, A., *Radio Manufacturers of the 1920s*, (Vestal, NY: The Vestal Press, Ltd. Vol. 2. p. 108.
23. Haeg, L., Jr., *Sixty Years Strong*, The Story of One of America's Great Stations, (1984) pp. 13, 14.
24. Barnow, E. *A Tower in Babel*, (1966) p. 156.



*George Freeman with examples of a radio manufacturer who put radio station WLW on the air to sell radios he manufactured. On the bottom, the 1922 Crosley Harko Senior; on top, its 1922 radio frequency tuned amplifier (RFTA).*

George Freeman graduated from Heidelberg College, Tiffin, OH with a speech major and BA degree in 1954. He began his broadcasting career that year as a staff announcer at WKST-AM/TV, New Castle, PA. He moved through the ranks; Top-40 DJ at WHOT-AM in his hometown, Youngstown, OH, back to WKST stations as news director, news editor at WBBW-AM, Youngstown, OH. New director, WNHC-AM, New Haven, CT, news director, WNBF-TV, AM/FM, Binghamton, NY, news director, WDRC-AM/FM, Hartford, CT, news editor, WNEW-TV, New York City, NY.

In 1961 he moved into marketing as account executive, WHCT-TV, Hartford, CT, then back to WDRC AM/FM as account executive. By 1967 he was general manager, WCCC AM/FM, Hartford, CT.

Freeman bought his first station, WGON-AM, Munising, MI in 1969. He put a companion FM station on the air there (WQXO), then bought KGRI AM/FM, Henderson, TX. All four stations were sold and he bought into a major market, Louisville, KY with WDGS-AM, New Albany, IN. The station was sold and he became a regional manager for the National Association of Broadcasters. He bought his sixth and final station WIKI-FM, Carrollton, KY in the early eighties and operated it for some 17 years before selling out in 1999.

At this writing, Freeman is vice president of the Indiana Historical Radio Society, board member and charter member of the Mid-South Antique Radio Collectors. He authors articles for both those clubs' publications. He writes the quarterly column, "Mics and Men" in the AWA *Old Timers Bulletin*.

Address: RALOGEUM, 133 E. Main St., 2nd Floor, Madison, IN 47250-3411, Phone: (812) 265-6878, E-Mail: ralogeum@aol.com.

## Notes

## Notes

## Notes

## Notes



## Notes